

THE RAUTE: NOTES ON A NOMADIC HUNTING AND GATHERING TRIBE OF NEPAL

Johan Reinhard

Vienna

INTRODUCTION.

Interest in hunting and gathering societies has increased considerably in recent years, primarily due to the realization of their importance in understanding the socio-economic evolution of mankind and to the fact that probably within our life-time the last of these societies will disappear allowing no chance for their study in the future.¹ As was so vividly pointed out in a symposium devoted to "Man the Hunter", about 99% of the time that cultural Man has been on earth has been spent as a hunter gatherer, and it was as a hunter-gatherer that the fundamental differences in biology sociology and psychology that separate man from the apes developed.² "When anthropologists speak of the unity of mankind, they are stating that the selection pressure of the hunting and gathering way of life were so similar and the result so successful that populations of Homo sapiens are still fundamentally the same everywhere"³

However, surprisingly little is known about hunter-gatherers and much of that is based on reports made by untrained observers, such as those made by missionaries,

-
- 1 The research upon which this article is based was supported by grants from the Wenner-Gren Foundation for Anthropological Research and the Austrian Academy of Sciences. The Research Council of Tribhuvan University, Kathmandu gave vital assistance in numerous ways. To all of these organizations I would like to express my sincere gratitude. I would also like to thank Nick Allen, James Fisher, Carleton Coon, Harka Gurung, and Andras Höfer for their comments on this paper. Tape recordings of the Raute language and dances have been deposited at the Phonogram Archives of the Austrian Academy of Sciences. A 16 mm. movie film and a few hundred slides remain in my personal possession.
 - 2 Lee, Richard and DeVore, Irvén "Problems in the Study of Hunters and Gatherers" in R. Lee and I. DeVore (eds.), *Man the Hunter*, Chicago, 1968, p. 30
 - 3 Washburn, Sherwood and Lancaster, C.S. "The Evolution of Hunting", in R. Lee and I. DeVore (eds.) *Man the Hunter*, Chicago, 1968, p. 293.

trappers, etc., or on ethnographic reconstruction from the memories of surviving members who no longer lead their previous ways of life. While valuable, such studies are no substitute for ones undertaken with the hunting and gathering societies themselves. These societies cannot, of course, be considered as relics from the Stone Age which will explain how hunting and gathering tribes at that time lived, but they are hunting and gathering societies *now* and, as such, can help anthropologists to gain a better understanding of how such societies may have functioned previously or at least point out problems in the interpretation of data concerning the hunter-gatherer way of life.

Contrary to the impression one might have from a brief look at popular anthropology books, there are very few truly nomadic hunting and gathering societies left in the world today. This is especially true in Asia where wars and a population explosion coupled with increased encroachment on previously untouched lands have been primary factors bringing about the disappearance of those few hunting and gathering societies as had survived until recent times.

These are some of the underlying reasons why, having read a report that one hunting and gathering tribe might still exist in the Himalayas, I decided to try and locate them and make a study of their culture. But before entering into a description of the tribe I did manage to come in contact with, some remarks as to the field-work situation are necessary in order to put this description into its proper perspective.

I went to Nepal in early 1968 to search for a hunting and gathering tribe called the Kusunda. I discovered that this tribe had almost become extinct, and I only worked a short period with them in order to gather basic ethnographic and linguistic data. I have written a brief article on this tribe elsewhere and will only state here that they are unique in our knowledge of Asian hunter-gatherers in speaking a language which has no apparent relationship to any of the major language families found in Asia.⁴

While searching for the Kusunda, I heard reports of another hunting and gathering tribe, the Raute, which was said to wander throughout parts of western Nepal. I later found mention of this tribe in an obscure Nepali history book, but much of the data appeared fanciful and its place next to remarks about an ape man left me unconvinced of its validity.⁵ As no one else in Kathmandu had seen or heard any reliable reports on what the Raute were really like— indeed most people thought they were a gypsy caste or didn't exist— I resolved to search for them in late 1968. I found the Raute after a three-week search, but anyone who has worked with tribes who have not encountered Westerners previously will understand the difficulties one has in overcoming their suspicions and fears. With the Raute, however, it went considerably

4 Reinhard, Johan "Aperçu sur les Kusunda : peuple chasseur du Népal" in *Objets et Mondes*, Volume IX, Part I, Paris, 1969, pp. 89-106.

5 Naraharinath, Yogi, *Itihas Prakash*, No. 2, Part I, Kathmandu, 1955.

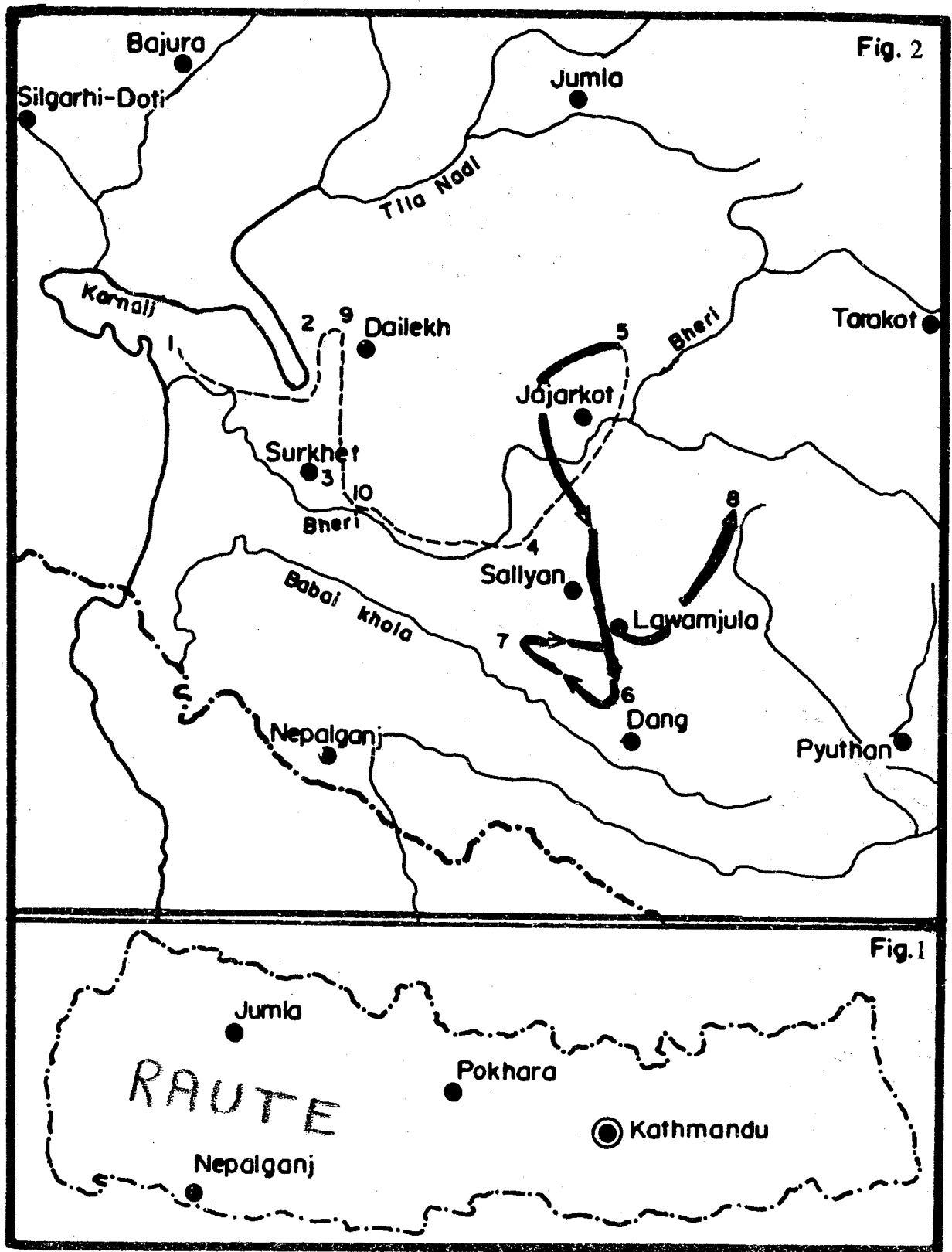

Fig. 1. Location of the Raute in Nepal.

Fig. 2. - - - - Approximate route of the Raute. ——— Route of the Raute, 1968-69.

1: Jan. 1966. 2: Nov. 1966. 3: Jan. 1967. 4: April 1967. 5: Sept. 1968
 6: Dec. 1968. 7: Jan. 1969. 8: March 1969. 9: Feb. 1972. 10: Jan. 1973.

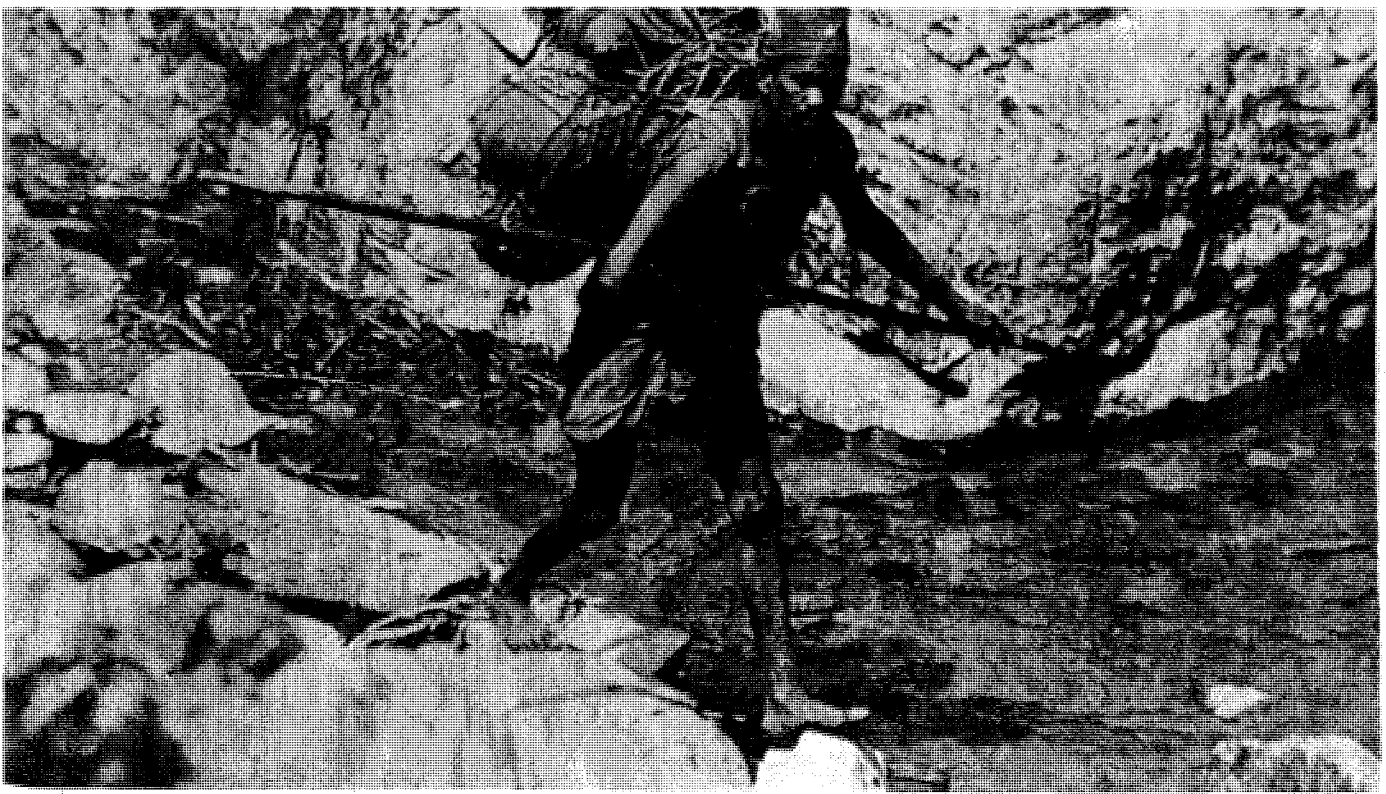

Plate I. Loaden with his possessions, a Raute is underway to a new campsite. The long staff is used in rigging a simple "tent".



Plate II. The Raute dance primarily in a circle with the drummers and a lead singer moving in front of the dancers. In this particular dance sticks are used and a mock combat occurs. A few of the dancers can be seen with white clothing worn only at dances.

beyond that for they will not allow extended relationships to develop with anyone outside their tribe. This is due to their belief that their hunting god will become angry and their hunting will be ruined. Since they will not allow anyone to follow them, or live near them, this means that the longest period one might work with them is about 3 weeks, i.e. the longest time that they are known to remain in one place.

I was fortunate in finding them at a time when they were in the process of making a new camp where they remained for a two week period and in being able to become a "mit", i.e. a "brother", of the leader. Much of the information presented here was gathered from this man. Although every way was tried to gain their confidence, when they moved they would not allow me to follow them for reasons mentioned above.

I had in the two week period been able to collect some notes on their culture, but as should be obvious it was not possible to collect much material, nor check much of it in any way. This was unfortunate as the Raute were clearly telling me more what they wanted an outsider to know of them than what was actually true. This data is in itself interesting, but leaves much of the material presented here open to question.

After a weeks' interlude I decided to follow the Raute as I was still uncertain as to how serious they were in their feelings, it being possible that their stated fear of their hunting being ruined was simply a ruse to keep outsiders away. It is difficult to summarize all the various approaches tried, but eventually I was able to gather more material and then had no choice but to leave.

After a few weeks in a village bringing notes up to date, my interpreter had to suddenly depart and I decided to follow the Raute again alone, but only to observe their movements unobtrusively rather than trying to work directly with them. I located them again after a two week trek at a time when they had split into two groups, and I observed what I could of each group for a two week period before they moved again and I finally abandoned my work with them.

* *

Given the questionable state of the material in this paper, I have often stated my own opinions about it wherever I felt necessary even though these opinions are hardly to be considered objective. The exploratory nature of this article should not be forgotten therefore, and I have written it primarily with two goals in mind. First, it is the only known data to appear in the Western literature on this tribe, and, secondly, I wanted to point out problem areas that might be looked into should any future research with this tribe be possible. The Raute are one of the last hunting and gathering tribes in Asia and any material presented on their culture, however scanty and open to question, should prove of interest to many students of human society.

PHYSICAL AND CULTURAL ENVIRONMENT.

The Raute roam through the middle hill region of West Nepal, lying between the Siwalik foothills to the south and the high Himalayan mountain range to the north. This area lies roughly between 80-82° longitude and on about 29° north latitude and is therefore within the temperate zone bordering the tropics. The altitude ranges between 2,000 feet in the lower river valleys and 10,000 feet in the mountains of the middle hill region. These mountains are geologically young and therefore are steep and rocky with deep and narrow river valleys. The mountains run generally in an East-West direction with rivers running down from the northern mountains to the south. Transportation is difficult with no roads at present built into this area and few bridges. Most goods are transported into the middle hills by porters who bring them from the bazaar towns on the Nepal-Indian border.

There are essentially three seasons; the summer, monsoon and winter. The summer begins about March-April and lasts until June when it is followed by the monsoon until about the end of September when winter begins. Temperature ranges from about 90° F in the summer to a mean temperature of 50° F in the winter with occasional frosts. Rainfall varies between 70-80 inches, most of which falls during the monsoon months.

Among the many tree types to be found in this area are pine, fir, juniper, oak, spruce, elm, cedar, birch and various species of bamboo. Several species of the *Dioscorea* yam and various fruits and berries are fairly abundant. Deer, mountain goats, monkeys, jackals, porcupines, bears and other animals inhabit the middle hills. Birds include hawks, doves, forest chickens, pheasants, crows and vultures.

The western hills are inhabited primarily by members of the twice-born Brahmin, Chhetri (Khas-Chhetri) and Thakuri castes—the latter two belonging to the Kshatriya “caste”—along with members of various untouchable castes, such as the Kami, Sarki, Badi, etc. Until fairly recently, there were few of the tribal groups, such as the Magars, Gurungs, and Tamangs of central and eastern Nepal to be found in this area. The inhabitants are settled agriculturalists, and primarily grow rice, maize, potatoes, wheat and millet. The area has lost much of its previous prosperity due to population increase and the increased clearing of forestland, overgrazing and erosion, and increased hunting and gathering as a supplementary source of food for the agriculturalists. Although the population density of about 90 persons per square mile is the lowest in the country, there is less arable land per capita than elsewhere, and the area is known as being one of the poorest and least developed areas in Nepal.⁶

6 McDougal, Charles *Village and Household Economy in Far Western Nepal*, Kathmandu, 1968, p. 2.

HISTORY AND LANGUAGE.

Although the Raute feel that they have always lived as they do today, and therefore may be considered as a historical and non-evolutionary in beliefs about their society, a general idea of conditions in times past can be gained from some historical documents and, reasoned speculation may be made as to Raute origins.

The Khas, the primary inhabitants of this area since historical times, have been noted in the Puranas (ancient Hindu texts) and in the Mahabharata, one of the classical epics depicting a battle thought to date from about 800 B.C.⁷ More recently the remains of developed Hindu kingdoms in this area dating around the 14th Century have been discovered.⁸ One may assume then that Western Nepal has been populated continuously for at least 1000 years and probably longer, and that the Raute have had some contact, however limited, with Hindu civilization for several centuries.

In this paper I have been referring to the Raute as if they consisted of one "tribe", which I will broadly refer to here as a group by which individuals identify with each other through a common language and culture. The Raute denied the existence of other Raute groups, and I could find no reliable accounts which would lead me to suspect the validity of their claim. However, in later research in Nepal I was able to prove their close relationship with the Rajis of Kumaon, a part of India bordering West Nepal, and of South west Nepal. Historically these groups were all hunters and gatherers, but the Rajis have been settled agriculturalists for some time, and they feel that they are unrelated with one another. It will not be possible to make a detailed comparison between these groups in this short article, and I intend to deal with this later in a monograph on the Raji of Nepal. Here it can only be said that the relationship has been established using fairly sound linguistic, cultural and historical data.

The name "Raute" is one of many applied to this tribe in the past, e.g. they are called Ban (forest) Rawat, Janggali and Banmanus (both meaning "men of the forest") Ban Raja (kings of the forest), Raji and Rautiya. The terms Raji, Raute, Rawat and Rautiya appear to all be based on a meaning of "lord" or "prince" and in this case used to distinguish the Raute as "lords of the forest" as opposed to the lords or kings

7 See: Basham, A.L. *The Wonder That was India*, London, 1954, p.39, for mention of the Mahabharata, and Berreman, Gerald, *Hindus of the Himalayas*, Berkeley, 1963, pp. 15-17, for remarks regarding the origin of the Khas.

8 Tucci, G. *Nepal, The Discovery of the Malla*, London. 1962. P.R. Sharma has recently written in greater detail on the history of West Nepal. See his book *Preliminary Study of the Art and Architecture of the Karnali Basin, West Nepal*. Paris, 1972.

of the cultivated land.⁹ Rawat or Raut are also common clan names particularly among high castes and the name of several early kings of Kumaon. The title "kings (or lords) of the forest" is fairly common among hunters and gatherers in India and Nepal, e.g. among the Birhor and Kusunda. To avoid possible confusion, I have continued to distinguish these groups, and shall use the term "Raute" to apply only to the hunting and gathering tribe still functioning as such today.

This takes us to an area of major concern among students of hunting and gathering societies, namely that of so-called "devolution" where a tribe may have originally been more economically advanced, but then regressed to hunting and gathering due to pressures from without. What took place 1,000 or more years ago is difficult for me even to conjecture, but in the light of the evidence at hand it would seem unlikely that the Raute have not been hunters and gatherers for several hundred years. This is not, however, to say that they have existed as an undisturbed enclave among more advanced peoples, as will be clear later in this paper. The Raute speak a Tibeto-Burman language which is not, aside from the Raji of Kumaon and SW Nepal, closely related to any of the other Tibeto-Burman speaking tribes in the Himalayas. In speaking their own language, the Raute are also linguistically fairly unique, for as Gardner has pointed out there are only a few hunting and gathering tribes in Asia which have not lost their own language and borrowed the language of their more dominant neighbours.¹⁰

Some of the Himalayan Tibeto-Burman languages (e.g. Limbu, Rai, Chepang), vary considerably from those languages which are more closely related to Tibetan, (e.g. Sherpa, Gurung, Tamang, Thakali), and it has been thought that this is due to an underlying substratum, probably Mundic, which dates back to a time when the Himalayan foothills were exclusively inhabited by hunting and gathering tribes. These tribal languages supposedly became influenced later by contact with Tibeto-Burman speaking peoples coming into the country from the northeast.¹¹

Whatever the case may be, it is generally conceded that these tribes were among the original inhabitants of Nepal, and it seems unlikely that the Raute were descendents of high caste Hindus, or kings, who inhabited West Nepal or Kumaon in the past.

Unfortunately, physical anthropology does not seem to help us much here, for the Raute show mixed features and any general description would probably find more

9 Crooke, William, *An Ethnographical Hand-Book for the NW Provinces and Oudh*. Allahabad, 1890. p. 180.

10 Gardner, Peter, "The Paylians" in M. Bicchieri (ed), *Hunters and Gatherers Today*, New York, 1972, p. 407.

11 Grierson, G. (ed.) *Linguistic Survey of India*, Vol I. Part, New Delhi 1927, p. 179.



Plate III. Six of the men are wearing a special dress for the dance. The Raute leader is one of the principal drummers.



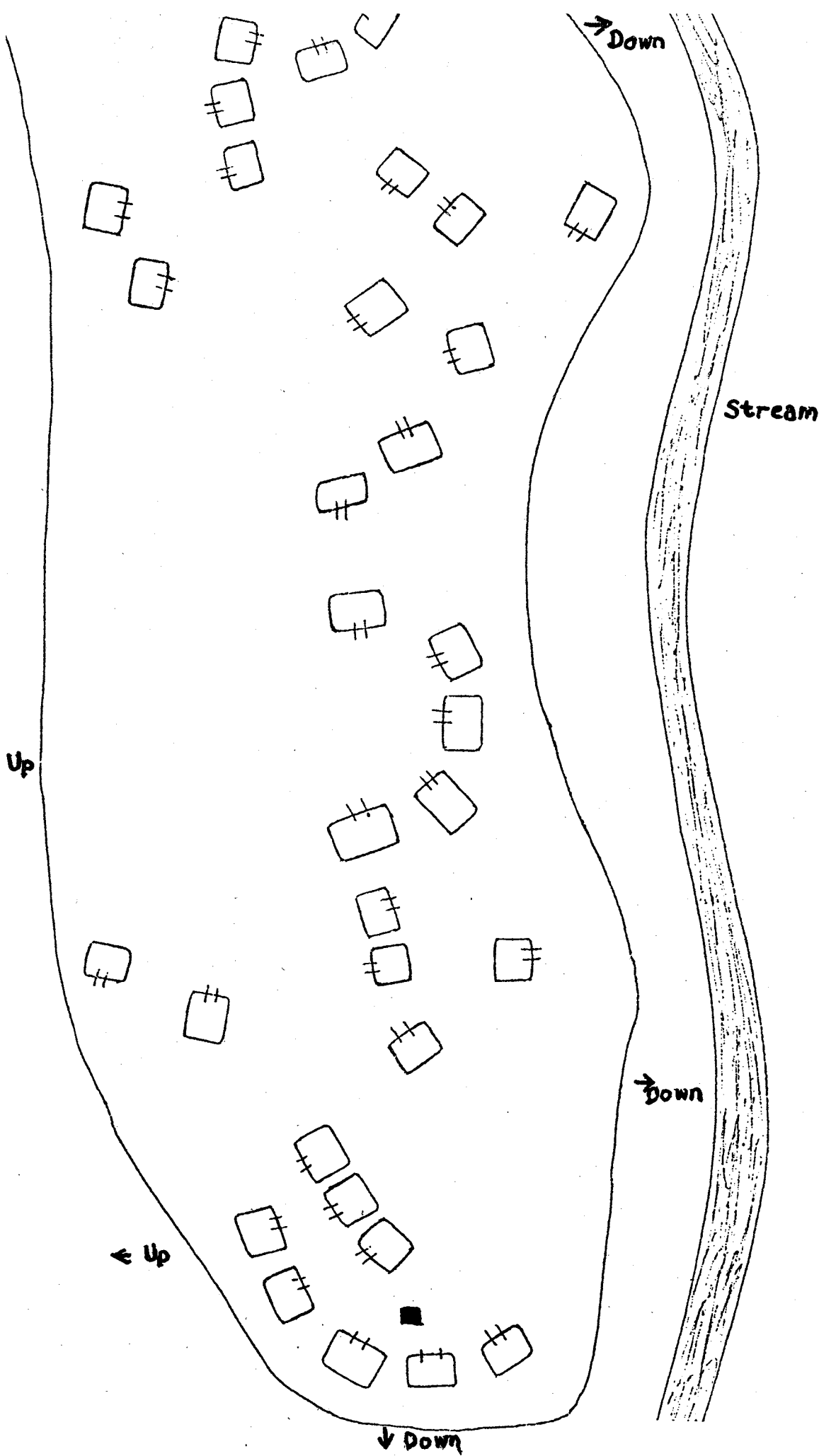

N
↑

Fig. 3. Date: 1/11/1969,

- Rice Mortar
- ☐ Hut Entrance.

Scale: 1" = 34' approx.

exceptions than examples that would fit it. However, it is interesting to note that the Raute do not have Mongoloid features which are as marked as those found among most other tribes in Nepal speaking Tibeto-Burman languages. Later in this paper some other aspects of this problem will be dealt with.

Coming to more recent times, aside from the work done among the Raji of Kumaon and mention of the Raute by name in some pamphlets, I am aware of only two published references to the Raute and both of these are in Nepali. The first of these was by Yogi Naraharinath, who in 1955 presented a few pages on the Raute.¹² The second was by Krishna Malla in 1961 in the *Gorkhapatra* newspaper.¹³ The latter contained only a few short paragraphs and was obviously information gained at second hand.

While I was working with the Raute, an ethnomusicologist, Terry Bech, came and recorded their music. I understand he is planning to publish an analysis of it in the near future. Most recently Dor Bahadur Bista visited the Raute for two days in early 1972. He has written a report on the Raute but unfortunately I have been as yet unable to obtain a copy of this. The information presented in this article remains, therefore, the most extensive yet to appear on this little known hunting and gathering tribe of the Himalayas.

ECONOMIC AND MATERIAL CULTURE.

If it is difficult to separate the economy from social structure and religion among more complex societies, it is much more so among hunting and gathering ones. The division made here is entirely artificial, therefore, and I have made no attempt to mark certain activities as "economic" or whatever, beyond my own personal feeling as to where they might best be dealt with.

One cannot speak of an "original" pre-contact Raute economy, which can be separated out of the present day one, as contacts with settled peoples have taken place over such a long period of time, and one can only speculate as to the economy in existence prior to such contacts. Further, as has been noted elsewhere, often as much as 90% of any tribal cultural inventory is borrowed.¹⁴ Today the Raute have an economy based primarily on the hunting of monkeys with nets, the trading of wood objects for foodstuffs and other essential items with villages, and the gathering of yams and other edible plants in the forest.

12 Naraharinath, *op.cit.*

13 Malla, Krishna, "Raute Jat" in *Gorkhapatra* (newspaper), Kathmandu, September 8, 1961.

14 Steward, Julian, "Causal Factors and Processes in the Evolution of Pre-farming Societies" in R. Lee and I. DeVore *Man the Hunter*, Chicago, 1968, p. 329.

The Raute roam over an area of between 2,000-4,500 square miles (see Fig. 1). In recent years they appear to have kept within about a 2,000 square mile area, but they claim, and other reports verify, that they have been much further east and west in the past. They have been found as far west as Doti District and as far east as Piu-than District, and at last report they are said to be heading towards the westernmost area. That a hunting band would travel over such a wide area is somewhat unusual among hunting and gathering societies with the average being about 100 square miles.¹⁵ That the Raute do this extensive traveling is no doubt due in part to an economy which places a premium on movement in all of its aspects. Resources would be less depleted for hunting and gathering and the "market" for wooden objects would not be exhausted. This use of a wide territory would seem also to imply a fairly extensive knowledge of flora, if not fauna (the Raute hunting exclusively monkeys).

Due to the difficulty in obtaining reliable data as to the time that the Raute were in a particular area, I have not been able to chart their movements through a long period of time. I have heard several stories of their keeping a 12 years cycle, i.e. revisiting an area 12 years later and maintaining a roughly circular pattern of travel in doing this, but I could find no substantiation of this when more intensive investigation was carried out, and the Raute themselves deny keeping any regular pattern of movement. A rough estimate of their route from 1966-69 is a fairly accurate portrayal of their movements, although it too is general and does not include division of the band and the roughly parallel routes that they followed (see Fig. 2). The Raute were later observed in Dailekh District in January-February, 1972 and in Surkhet District in January, 1973.¹⁶

The route appears to be somewhat influenced by the climate, as the Raute appeared in the hotter valleys during the winter months and the high mountain areas in the summer months. No definite correlations with any particular plant cycles or animal movements could be established, however.¹⁷ It should perhaps be noted here

¹⁵ Steward, Julian "The Economic and Social Basis of Primitive Bands" In R. Lcwie (ed.), *Essays in Anthropology in Honor of A.L. Kroeber*. Berkeley, 1936, p. 333.

¹⁶ Personal communication with Allen Fairbanks and Naveen Kumar Rai, respectively.

¹⁷ Atkinson has noted that the langur feeds on a wide variety of fruits and flowers and on buds and young leaves of many types of trees. However, between August and February acorns form its chief food and then the langur is found particularly in oak forests. A different species of langur is found to the north of the outer hills and appears to be permanently resident there. Just how much this influences the movements of the Raute remains uncertain. See Atkinson, E. *The Himalayan Districts of the North-Western Provinces of India*, Vol. II, Allahabad, 1884, p. 4.

that the Raute were heading towards Surkhet, my base of operation, when I met them and they apparently changed direction in order to avoid my following them.

Reports that the Raute never crossed bridges proved to be false. However, they did build boats in the past to cross rivers where no bridges were available. They avoided paying a bridge fee by claiming to be jungle people without money and not subject to villagers' laws.

It has been noted among other hunting and gathering tribes that a fluid band organization has advantages in adapting group size to resources. The Raute band will divide when the available resources and trading possibilities reach critical level in relation to group size. These smaller bands will follow roughly parallel routes and join again later. It is not possible to state precisely how much of the time is spent divided into what I will call here "secondary bands", but based on reports and my own experience it appears to occur roughly 50% of the time. In speaking of the Raute "band" or "tribe", I will be referring to the main group composed of all Raute members.

Economic activities are divided according to the sexes with hunting and wood carving being the principal activities of the men and gathering primarily that of the women. The Raute exploit very little of the available animal life for they claim to hunt exclusively the rhesus and langur monkeys. They are one of only a few hunting and gathering tribes known to hunt land animals with nets.¹⁸ I could find no evidence to support the occasional stories I'd been told by villagers that other game was hunted or that hunting implements other than a net were used in their capture. Contrary to the Birhor in India who also hunt monkeys, the Raute are unable to market the skins and thus meat is the only benefit obtained from their hunting.¹⁹ The Raute claim no preference for either rhesus or langur meat. But there are numerous stories of the langur being their favorite food.

The Raute feel that it would be unlucky for any villager to observe them during a hunt or while they are preparing and eating the game. I have seen more than 30 Raute return from a hunt laden with dead monkeys and, seeing me in the distance, deliberately place their game and eat it out of my field of vision. Some villagers claimed that Raute have offered them monkey meat when they happened by at the time it was being divided, and they would take the meat out of fear that the Raute would harm them should they refuse. They would not eat it as they feel it a sin to kill or eat

¹⁸ In his survey of hunting and gathering tribes, Carleton Coon could find only three known cases. See his book *The Hunting Peoples*, Boston, 1971, p. 98.

¹⁹ Sinha, D.P. "The Bihors" in M. Bicchieri (ed.), *Hunters and Gatherers Today*, New York, 1972, p. 378.

monkeys. Whether or not these claims are true remains to be seen. The Raute stated that they never give villagers monkey meat, or even let them view it, if at all possible. It is interesting to note that the practice of not allowing villagers to observe them killing and eating monkeys also serves to minimize the disgust with which many villagers view these acts, and helps prevent ill feelings in this regards.

Although villagers will not kill monkeys themselves, they will sometimes ask the Raute to come into an area to kill monkeys which have been ravaging their crops. The exclusive hunting of monkeys appears to be especially advantageous in that monkeys are not hunted by villagers and are considered pests by them whereas many other game animals are hunted. There is, therefore, no serious depletion of monkeys as a food source for the Raute due to competition with the villagers and thus no animosity between the villagers and Raute arises from this source. The hunting of deer, pheasant, etc., would mean a depletion of game which a villager would himself desire.

The hunt can involve only a few men, but, as this is said to often be unsuccessful, the Raute normally hunt in groups of more than 10. Hunting monkeys with nets would seem to put a premium on large band size as the more men available (to a certain point) the more game per man which can be obtained. This will be clearer from a description of the hunting methods below.

Monkey hunting with nets necessitates a cooperative effort while enabling men to remain relatively close to camp. This is somewhat of a different order than, say, hunting large game requiring days of stalking and pursuit. This may be one reason that the Raute claimed that they do not divide into more than two secondary bands. If the main band divided into several secondary bands and covered a wider territory, there would be a greater ability for one group to stay a long time in one place as far as trading of wooden objects and gathering forest produce is concerned, but it would mean a decrease in the amount of game to be eaten. A longer stay would undoubtedly entail increased contact with villagers and an increasingly filthy campsite and spring water. Hence a band which is large enough for group hunting, yet not so large that resources would be depleted in a day or two, would seem to be ideal. From the Raute standpoint about a 1—2 week stay would appear to be a good length of time to remain in one place, as it would be long enough to exploit trading and hunting and gathering possibilities within a fairly large area and yet not be too long to upset villagers through the cutting of trees, and perhaps by gathering forest produce, or having too prolonged contact with them. It would also make the time and energy expended in setting up a camp worthwhile and enable men to cut trees and completely prepare and trade wood objects. Thus in areas of relative plenty, a band of around 100 people could have sufficient resources for the length of time they would probably prefer to remain in any event.



Plate V. Raute children holding staffs used for "pole-vaulting".

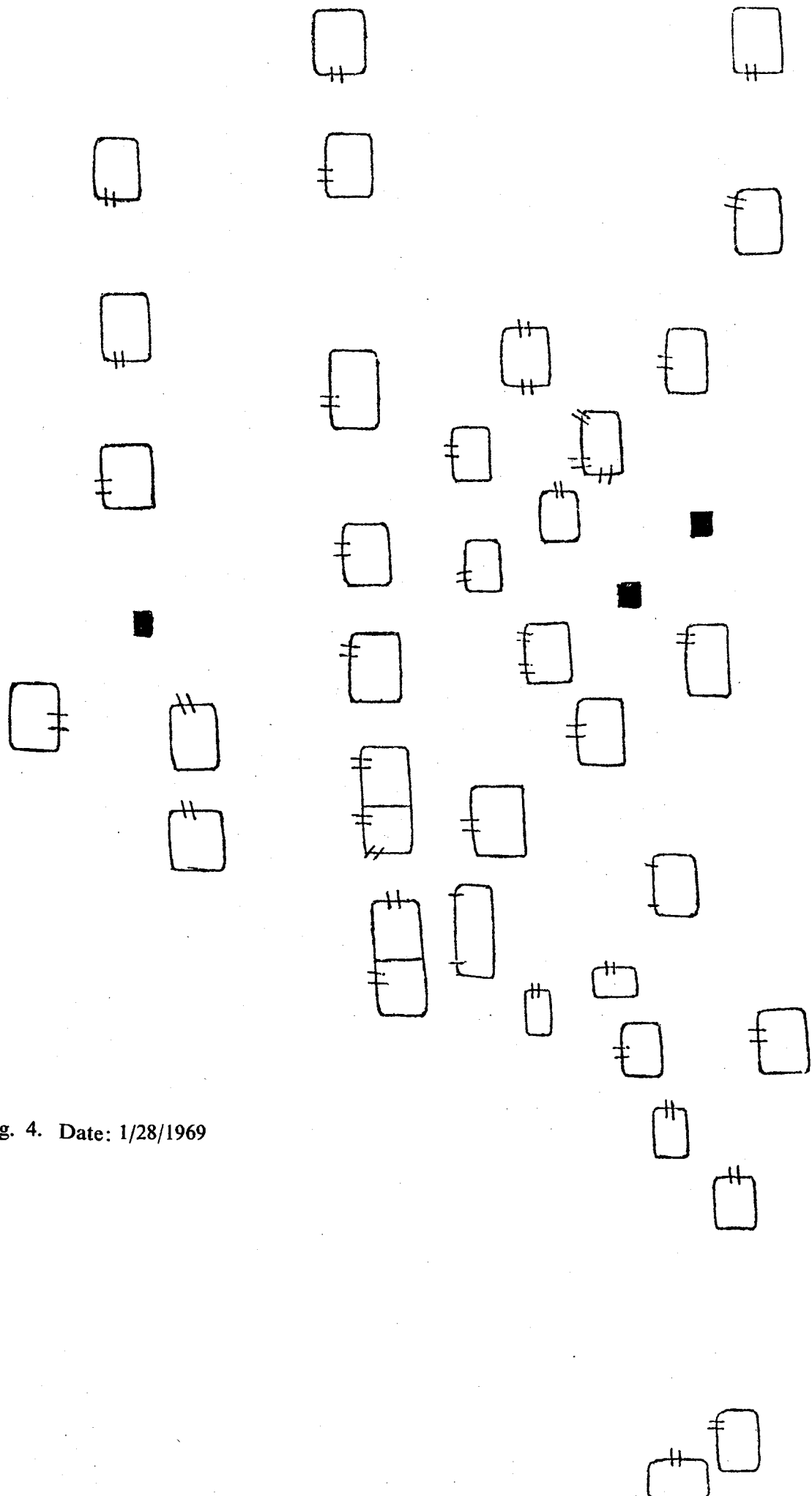

Fig. 4. Date: 1/28/1969

In areas of scarcity and limited trading possibilities the main band must, however, divide in order to maintain some balance as indicated above. It may also be helpful to divide should they desire to move through an area quickly. Having to travel several hours to trade a vessel would be inconducive to rapid attainment of food resources, so a smaller area must be exploited when not remaining for more than a day in one site. This would obviously create a greater need for band division. Reasons for rapid movement might range from a desire to leave an area due to hostile contact with villagers or simply to get to an area where hunting, gathering and trading are known to be better. Further, in areas where hunting is poor, there is less reason for the band to remain as large as it is. I have dealt here primarily with economic factors at work in determining band size. Later I will refer to some social factors at play.

The Raute set up a new camp in areas of plenty no further than one hour's walk from the previous one. If necessary, while moving camp they will mark the trail for others to follow by placing a stone on top of a branch or a bundle of grass with the tip pointing in the direction taken.

The primary method used in the hunting of monkeys is to set up nets and have a few men hide near them with clubs and axes. Others drive the monkeys from three sides by yelling and whistling into the area where the nets have been set up. They would then kill the monkeys with axes and clubs as they struggled in the nets. I was told that the nets were strung between trees, but a villager, who claimed to have hidden and observed the Raute during a hunt, informed me of a different method employed. He stated that the nets, which are only about 5' x 4', are placed *horizontally* about 2' above the ground in a small clearing. Each net was supported at the corners by ropes leading to three foot poles stuck firmly into the ground. The nets were staggered such as to leave no eventual opening for the monkeys to escape through. As the monkeys were caught in the netting, the poles gave a little while they struggled enabling them to become still more entangled until they were finally killed by the Raute. Here it may be seen that the more men that can be hidden and used to encircle the monkeys, the more monkeys that can be obtained in a hunt. It would be difficult for only a few men either to encircle the monkey band or to kill those caught before they could escape.

Another method used in hunting monkeys, especially when monkeys are seen while returning from trading, is for the men to try and tire the monkeys by chasing them. If possible, men will climb trees and throw stones in order to bring the monkeys down. Raute said that this method was rarely very successful. Contrary to villagers' beliefs, the Raute claim that no use of magic is employed in their hunts, nor are special offerings or prayers made prior to, or following, a hunt.

There are no special hunting groups, i.e. made up of specific relatives, age groups, etc., and the number of men joining in a hunt can vary from only a few to

virtually the entire male population old enough to participate physically. There is no hunting leader and decisions as to various aspects of a hunt are reached through consensus.

The game is said to be divided equally among those who participated in the hunt, with those people who remained in camp receiving a somewhat smaller share. The division is not dependent upon the size of a hunter's family, and no special parts of the monkey are given to any particular person. Those men, including their families, who were in the villages trading wooden objects that day, do not receive anything, otherwise the Raute feel that their hunting god would become angry. Since it would be probable that the men involved in trading would have obtained grain foods, one would assume that no particular hardship would fall upon them by not being able to share in game acquired.

The nets used for hunting are made and owned individually and may also be used for carrying goods while moving camp. They are made from strips of a tree bark or of a vine which is stripped, beaten, cooked, again beaten, and then dried and separated before finally being rolled into a cord for the construction of the nets.

The Raute make wooden objects for which the villagers provide a ready and willing market. In difficult times they will sometimes try the "hard sell", i.e., pressing people to trade for them, but apparently this is not common. They will make things specially to order, but generally rely on the trading of wooden bowls in villages in exchange for grain foods such as rice and maize. These foods form the basis, along with plants gathered in the forest, of their food supply.

Numerous woods are used for the construction of the various objects made. A tree is felled and a cross section cut out to be taken back to work on in camp. It is important to use fresh wood as dry wood would be harder to work and would break easily. Principally made are simple, undecorated wooden bowls of various sizes. On occasion lids may be made to fit these. The bowls are used by villagers for keeping curd, butter, oil, etc. Wooden seats, boxes and even dual purpose sleeping plank-storage boxes are made, although the latter are normally only made to order. The sleeping plank-storage box consists of a large wood box with a long plank as a lid upon which a man may sleep to insure that his possessions will not be stolen during the night. These are the objects most commonly made, but Raute claim they will make more complicated objects, e.g., a boat, if ordered.

Long and shorthanded axes, large and small adzes, and a long chisel are the primary tools used in wood working. The iron parts of these tools are obtained in trade from village blacksmiths. The construction of a medium sized bowl is a matter of a few hours' work. The bowl is held against some obstacle, often a log set against pegs, and worked on with an adze. A large box will take approximately two days and

a sleeping plank-storage box may take four days to complete. A box is made by cutting a tree trunk in half and then cutting out horizontal wood sections, which will serve as the sides and lid of the box. These are carefully marked as to where edges are to be joined, and grooves are cut with a chisel, using the back of an adze as a hammer.

Normally grain is obtained in trade for bowls and the amount is determined quite simply. Rather than use the Nepali measuring system—and perhaps be cheated by clever villagers—the Raute take as much grain as it takes to fill the bowl or box until it is level at the top. If it has a lid, then the grain must fill the bowl to overflowing. As a rough indication of the amount that such bowls are worth, I gave grain valued at 2 Rs., 3 Rs. and 4 Rs. in exchange for three bowls of different sizes. Grain valued at 2 Rs. (about a dollar 0.20) in this area was approximately enough for two meals for one adult. For one box I gave 84 pounds of unhusked rice valued at roughly 30 Rs. I saw one Raute man receive cloth 20 yards long and one yard wide for one sleeping plank-storage box, and two goats (worth about 100 Rs.) for another. Apparently in the past bowls came at a somewhat cheaper rate (or grain was harder to come by), as I heard many stories of a Raute taking only as much grain as would fill a bowl up to his thumb placed over the inside bowl edge. This may still be done today in areas of scarcity. On rare occasions money may be taken for objects in order to obtain something else from a villager which cannot be obtained by trade. The item obtained in trade, whatever it may be, becomes the property of the man who made an object and traded it.

The Raute also make two bowls for their own use which are distinct from those traded to villagers. One is a wide, low-rimmed bowl for eating rice, and the other is a small, deep bowl for eating vegetables, with a spout at one side allowing juice to be poured out. In addition a flat disc-shaped wooden spatula is made for stirring and dishing out rice, etc. Interestingly, the Raute use two wooden containers made by another caste. Both of these come in different sizes and are made by hand lathes which the Raute do not possess. One is used for storing water and the other, larger type is used for keeping beer or obtaining water far from camp.

Raute men will normally carry a load of vessels with them to surrounding villages to barter. If someone states that they want a bowl, then the Raute consider it a binding agreement and are quick to anger should someone later change his mind. Grain is placed in a blanket for carrying and a blessing is said over a bowl which runs roughly as follows: "I give this bowl a blessing that its owner may be wealthy and always have milk, fresh meat, and rice, and that this bowl may last from grandson to the son of the grandson."

I was told that widows will be given bowls to trade by relatives who care for them and that they can keep the grain acquired, but this did not occur while I was with the Raute.

The Raute try to be friendly while trading wood objects but at the same time avoid any prolonged contact with the villagers. They never stay overnight in a village or away from their camp. Should villagers become too curious, the Raute will not hesitate to show a quick temper and tell villagers to leave them alone. The religious prohibition against prolonged contact with villagers, due to a fear of their hunting god becoming angry, is one which villagers can understand and normally there are few conflicts. Villagers' views of the Raute will be discussed later, but in relation to wood-working the Raute seem to be caught in an unpleasant circle. They are now reliant on trade with villagers, but to make the objects required they need to cut down trees. This in turn angers some villagers who would like to see the government stop the Raute from this practice. Some Raute claimed that they have or had a paper from the government allowing them to cut trees while others have admitted to me that they have no such paper but they are jungle men who are not subject to the laws of the villagers. They say they have always done this work and it is necessary for their existence. They apparently have also told villagers that they pay taxes to the Kusunda, the acknowledged "Ban Rajā" (Kings of the Forest), and therefore do not have to pay the government anything. This seems a clever way to lessen conflicts with villagers but not to have any basis in fact.

After trading in an area the Raute will not return for some time, indeed perhaps not for years, as they feel it will take time for the objects they traded to become broken etc. and the need for more objects arises. This serves as a good conservation practice as monkeys, too, will have time to repopulate the area. By this it should not be taken that the monkeys are completely hunted out, however, as one can often find them in areas where the Raute have camped for weeks.

The Raute make an effort to keep freshly made wood objects out of the sun and wind and will even at times place them in water to keep them from drying and cracking. Wooden objects made for villagers are rubbed with wet red earth as it is thought to add strength and good luck. Ideally the substance left over from pressed mustard seeds should be rubbed on them and cow dung may be rubbed on boxes. Women often are the ones who collect the red earth and apply it to the objects.

The trading of wood objects is not only an important source of basic subsistence foods, it is also a means of obtaining needed items from villagers such as salt, baskets, tools, cooking utensils, cloth, etc. It further enables the Raute to collect a short-term, but important surplus by acquiring goats, chickens and grain beyond their immediate needs. Once a large proportion of the band possesses a surplus more time can be devoted to hunting and to drinking, dancing, etc. Such a surplus did accumulate immediately prior to my arrival but normally one would expect that any surplus is acquired more on an individual basis and utilized according to the needs and desires of a man's immediate family.

N ↗

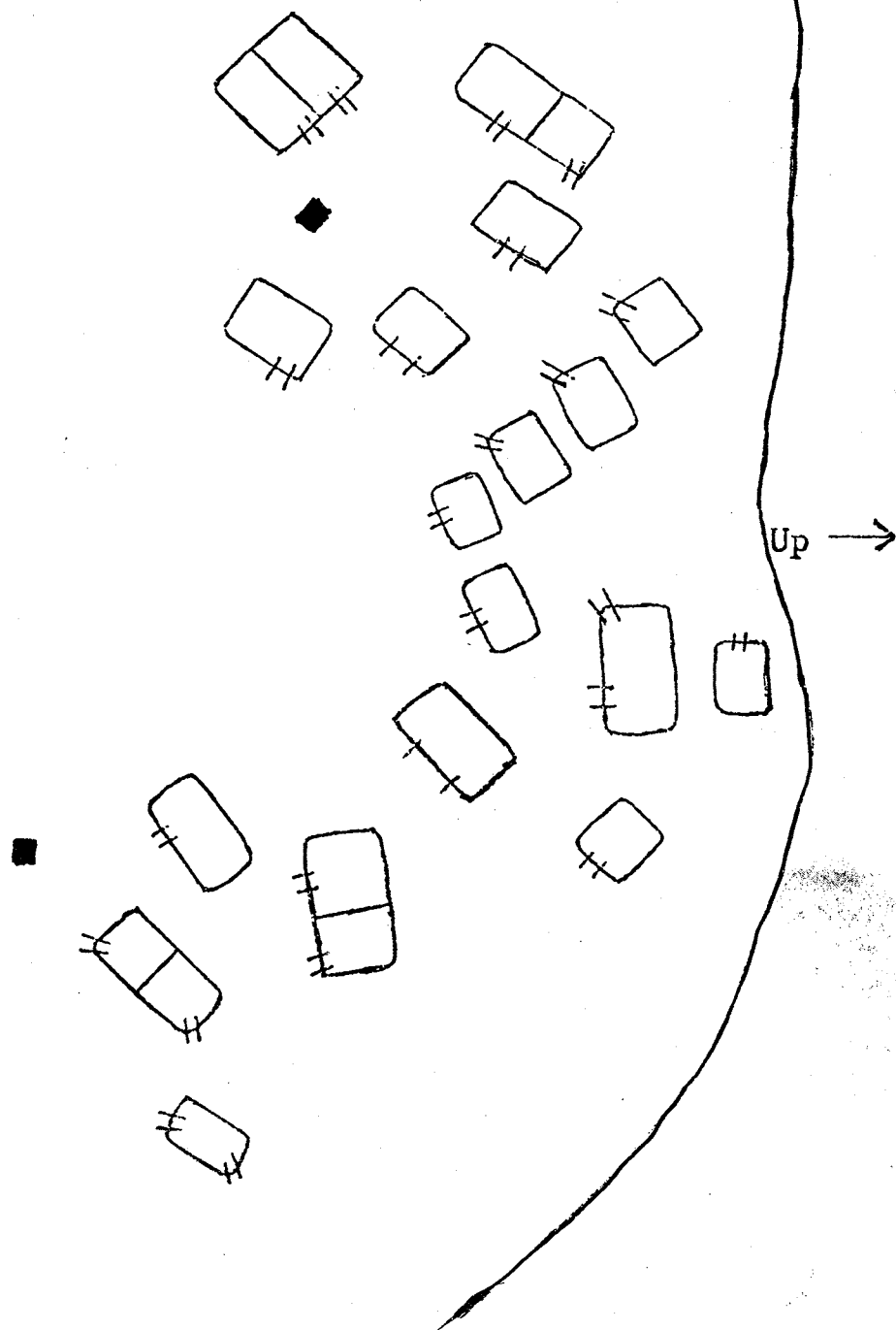

Fig. 5. Date: 3/26/1969



Plate VI. The two Raute on the left are trading wood bowls for grains.



Plate VII. A view into the camp shown in figure 5. This photo was taken after it had rained, hence several of the huts have been reinforced with grass and blankets put out to dry.

Grain foods obtained from trading do provide a fairly reliable food source, but in order to supplement this and to have food on hand should nothing be obtained hunting or trading the women gather plants, particularly yams, in the forest. Although many plants are utilized by the Raute, without having specimens I was unable to identify these botanically. There did not appear to be a regular pattern for the obtaining of nuts, berries, etc., and I was told that these were normally gathered along the way without any attempt to systematically exploit those available in the forest.

The women leave in small groups and search especially for *Dioscorea* yams of which the *Dioscorea daemlnia* is the most desired. It is less available than the *Dioscorea sativa* which seems to supply most of the food supply obtained from gathering. These yams are normally dug out of the ground using hoes or sharpened sticks.

I have no knowledge of the seasonal and regional availability of forest produce but would suspect that the Raute remain relatively uninfluenced by this factor in their wanderings, as other aspects of the economy, the trading and hunting, would not seem to be closely tied to these variations. There appear to be some edible plants available at any time of the year. The type of grain obtained in trade will vary according to the time and place the Raute visit, with rice readily available in the south in the winter months following the harvest and maize and millet being the primary grain foods available in the hot season and monsoon. Apparently monkeys are available at all times in West Nepal although more prevalent in some areas than others. As villagers also are known to eat yams and other forest produce, one would imagine that with increased population and clearing of new areas, that the amount available would be less than in the past. This would however mean an increase in trading possibilities and no necessary decrease in monkeys.

The Raute do not fish, but there is no prohibition against the eating of fish should the opportunity arise. Some Raute claimed not to eat field mice but others admitted doing so, and, if true this would seem a fairly abundant source of meat, although from my own experience I would doubt that mice take up a significant proportion of the diet. Rumors that the Raute begged for food proved to be untrue, although there is one mentally disturbed Raute who is known to do this and even to sleep in villages. His behavior, however, is considered very abnormal.

The Raute men carry small pouches in which they keep fresh tobacco leaves which are eaten at their leisure. This is a favorite practice of the Raute and conflicts have been known to arise with villagers due to the Raute stealing their tobacco. One may also see domestic melons, gourds, greens, etc., at a Raute camp and, although some are occasionally given to the Raute by villagers, many are said to have been stolen from their fields. This seems to be done at a minor level and rarely to cause overt friction. One would suspect, however, that should the Raute remain very long in the area, eventually conflicts would arise due to such activities.

It is impossible to make an accurate breakdown as to the amount of time spent on different aspects of the economy, i.e. on gathering, trading and hunting. The latter two especially would vary from place to place depending on the possibilities and so would therefore the relative percentage of food that each activity would contribute to the daily subsistence. While I was with the Raute, I would estimate that about one third of the time was devoted to hunting with the other two-thirds spent in the making and trading of wood objects. Women spent roughly 3-4 hours in the forest collecting edible plants and about an hour cutting and collecting firewood, with the remaining time spent preparing food, repairing huts, etc.

That the Raute have an occasional surplus can be seen in their appearance. Women wear clothes, earrings, bracelets, and necklaces, while men have clothes, pouches, earrings, etc., and all of these items are obtained in trade with villagers. Both men and women wear clothing which was more common among villagers in the past, but is now going out of fashion. Aside from this, only the old, mixed and patched nature of the clothing indicates that the Raute are any different from the villagers in appearance. Some Raute also have special clothes worn only at dances. Like the villagers, they go barefoot, but would like to have shoes to prevent getting thorns in their feet, and probably as a sign of status. I have seen one boy going hunting wearing one old shoe too big for his foot and clearly more of a hindrance than a help to him. Rips in clothing are sewn by the women, but any extensive sewing of cloth is done by a village tailor.

According to villagers the Raute never wash themselves or their clothes except at the death of someone, and I personally never saw any washing done, or any indication that it had been done, while I was with them. They have the interesting custom of drinking only spring water and never flowing water, as they feel it is dirty due to villagers and animals having been in it. Since springs are not always available at a campsite, they cleverly avoid drinking water from streams by digging a hole near it and in effect creating their own spring. I have noticed that they will even wash yams and clean bowls in spring water after eating rather than use a nearby stream.

The Raute primarily live in huts of which two basic types can be distinguished. These vary somewhat according to the terrain, climate and duration of stay. The first type built near raised ground, as in a terraced field or on a hillside, has one stick about 6-9' long set on top of two forked sticks about 4' high with a similar, but lower, construction built a few feet further out. Branches supported against the raised ground are then laid across the horizontal poles. In a flat area there is the same construction as in the first type but the lower poles are missing and, with no raised ground to support the branches, they are simply laid against the horizontal pole with further branches laid across the outward, extending branches to bend them down over the open side of the hut. Occasionally huts are made with branches laid across the hori-

zontal pole from both sides. Huts range in width from about 5'-8', are about 4' in height and 6'-9' long. Finally, the Raute will also utilize overhangs and caves when available.

In observing the establishment of a new camp it was primarily the women who were seen to build the huts. Most of the huts were built on a hillside. Therefore, the area had to be leveled and the outer side of the huts shored up with rocks. Branches were cut and some tied together with ropes made of twisted grass. Once the huts were completed, the Raute placed their possessions inside. At this same site a storm occurred and the huts were made more weatherproof by covering them with large amounts of tough grass. Some Raute made "tents" inside the huts by suspending a second horizontal pole under the first and laying a blanket over it which was then fastened to stakes at the sides. Raute sometimes carry poles to use for the main horizontal pole for the hut or for rigging a tent, and it seems likely that such tents would be used more frequently in less forested areas. To enable water to run off, trenches were built around the outside or inner edges of the huts. Men occasionally helped in construction of the huts, but most of the work described above was done by the women.

There is normally a hole dug in the center of the hut for the fire. Pine needles, straw or leaves may be set at one or two sides to sleep on and firewood may be placed at another side. Iron cooking stands were seen in several huts, and, where these were not available, three stones served as a substitute. Cooking pots, cooking utensils, wooden bowls, wooden water containers, axes, blankets and adzes are common. Twigs, tied, together to serve as brooms, are also often used. A few Raute have baskets, bamboo-and-leaf rain covers, hoes, knives and winnowing trays. An earthen water jug and a bill hook were also seen. All of these items are made by villagers and obtained through trade. A wood rack hung over the fire and a wood platform placed over the fire are used for keeping meat for short periods. No long term preservation of meat is attempted, i.e. through such techniques as smoking, drying and salting, etc.

The Raute also smoke and frequently ask villagers for Nepali "cigarettes". Two "hukkas" (waterpipes) were seen and I was told they are primarily smoked by old men and women. Beer made from various grain foods, of which rice is the favorite, is greatly enjoyed by the Raute and made whenever the surplus allows.

There was said to be no set eating order, and, if men were late, the women and children would eat first. In observing camp life it became clear, however, that normally the men eat first, followed by the children and women.

The fire, started by striking flint with a piece of metal, may be made by anyone and once having been made in one hut will be taken to other huts. The ideal meal for a Raute would seem to be some grain food, monkey meat, greens and yams with red peppers and salt. Oils and butter are rarely used. The meals are eaten with

the right hand as Nepalis do. Monkey meat is prepared simply by roasting it in the fire and is normally not well done. Goats are tossed live on to a fire after having their feet tied, and this is thought to make for better tasting meat.

The preparation of the foods, be they rice, maize, millet, or whatever, is the same as that done by the villagers and will not be dealt with here beyond stating that in each camp there are usually one or two areas where rice is husked using long wooden poles as pestles and wooden blocks with holes as mortars. These and winnowing trays are shared among the Raute on a first come, first served basis. These items along with flat stones used for crushing maize, salt, peppers, etc., are common among villagers also. Although the preparation of food is primarily the work of women, men may also winnow and husk rice if the need arises.

It would be interesting to find out how the distribution of food really works in Raute society. One would expect that it would be difficult to refuse food to relatives and that surpluses would be quickly dissipated. As is common among hunter-gatherers, there appears to be a lack of wealth disparities among the Raute, and any extreme imbalance that would arise would soon be dealt with through distribution or painful social sanctions. As the leader once told me, "I may be rich by staying with you, but what is that worth if my people will be angry with me?" The Raute do keep individual ownership of the tools they use, but the structure of the economy through cooperative hunting and trading in constantly changing areas—where no one can develop a special "clientele"—seems to work adequately to see that the distribution of wealth is equalized. It is difficult to imagine indebtedness occurring, as loans would probably be made in terms of a general reciprocity. Resources, be they trees or wood objects, forest produce or monkeys, are available to all.

During the time I was with the Raute, a normal day consisted of people rising at 5:30 A.M. with the women getting wood and water and preparing food. Fires were burning by 7:00 and families were eating at odd times between 9:00 and 11:00. Men were working on wood objects in the early morning and some would leave even before eating to trade objects in nearby villages. Others waited until after eating, when small groups of women would go gather forest produce and cut wood. Some men would remain the entire day working on wood objects, but normally only a few people would remain in the camp after noon. People would begin to return in odd bunches throughout the day with fires started again at 4:00 and the preparation of foods begun for the evening meal. At about this time firewood would be collected. Several men, especially the hunters, would not return until almost dark. Supper would be eaten around 7:00 P.M. and the last sound of the few men working on wood objects after supper would be heard at about 9:00.

The Raute utilize only a small proportion of the available food resources, yet we have seen that they never go hungry and even at times manage to obtain a

surplus. They appear in much better physical condition than the villagers who eat much less meat in this protein-deficient area. Due to their flexible socio-economic system, they would never seem to have the fear of a famine and indebtedness that a farmer faces. But for all this, the Raute could hardly be said to have an affluent society. They do manage to survive comfortably, but only through constant work and long days. One would make a mistake, however, if he thought the Raute viewed this as a hard, cruel life. They know no other way, and do not want to know another way, for they strongly feel this is their god-given way of life.

One may ask why I have stressed hunting rather than trading in the title of this paper. Although the trading of wood objects plays so important a role in Raute economy at present, it is as nomadic hunters that the Raute feel themselves different from villagers, and it is hunting which is most important in the religio-ideological sphere. When they say they cannot have much contact with villagers, it is due to fear that their hunting god will become angry and ruin their hunting. That hunting doesn't play an even more important part in the economy is most likely due to extraneous factors and not to any lesser importance in the minds of the Raute themselves. It is hunting that has historically played a primary role in giving the Raute society the form it has today. For these reasons, if one word must be chosen to characterize this tribe, the term "hunters" still seems the best one to use. Some of this will be clearer after we deal with Raute social structure and religion. Finally, from the above description of the economy it seems plain that the Raute have developed an economy flexible enough to meet almost any situation, adaptive to their cultural-environmental circumstances, and in keeping with their beliefs and way of life.

SOCIAL STRUCTURE

In this article I have used the term "band" to mean the main group comprising all of the Raute, especially in reference to socio-economic activities, and the term "tribe" when referring to the Raute as contrasted with other tribes and castes.

Although the Raute, being a tribe originally outside of the Hindu caste system, cannot be placed by villagers into this system with any certainty, they have certainly been viewed by them as making up a distinct caste. Customs which more orthodox Hindus would find offensive, such as the killing of monkeys, which they view as sinful, and eating from wooden bowls which cannot be purified by washing with water, are not sufficient in themselves to cause villagers to place the Raute in the untouchable caste category. However, they are also not viewed as belonging to the higher echelons of the caste hierarchy, although the Raute themselves make this claim.

The Raute feel they belong to the twice-born Kshatriya (Chhetri and Thakuri) "caste" which is second only to the Brahmins in the caste system. However,

they do not wear the sacred thread nor do they keep any of the other caste customs associated with this caste. This claim on the part of a tribal group to Kshatriya status is common in Nepal, but rarely has it been recognized by the higher castes. The Raute seem to base their claim on the fact that they are kings of the forest and the kings of the cultivated lands are Kshatriyas. One might ask why they bother to make the claim at all. This seems to be based on a desire to keep some status vis-à-vis the other castes in this area, the majority being of the twice-born category. There is, indeed, even a Raute Chhetri group, but both the Raute and the Raute Chhetris disclaim having any relationship to one another. As the Raute have so few dealings with villagers where caste would play an important role, e.g., as in interdining, there seem to be no problems arising in this regard. They claim they would not accept cooked food from a caste not of the twice-born category, but it would seem that such a situation would rarely arise.

The Raute also claim to have clans, the names of which are the same as those found among the Kshatriyas (Thakuris), e.g., Raskote, Sahi, Samal, Malla, etc. I could not, however, find any basis for this in reality, and it appears to be simply another way of trying to convince villagers of their high caste position. Some historical and linguistic reasons as to why their claim appears unlikely have been stated previously in this paper. In doing research with them I found that they could never agree as to how many clans they had or what clans they belonged to and eventually a few Raute admitted that clans weren't important and two people admitted that they didn't exist at all. This would be expected, as it seems doubtful that they would have such a restrictive institution as a clan in their social structure with the choice of marriage partners already so limited. As one woman said to me, "Raute don't have houses, Raute don't have empty heads, Raute don't have clans."

I was also not able to find any symbolical objectification of a lineage, e.g. there was said to be no inherited property, no lineage name, no lineage deity, etc. The Raute leader summed this up nicely when he said that they did not keep track of "generations and relatives like village people". Well-developed patri- or matrilineages seem to be less common than was previously assumed among hunters and gatherers, and the same may be said for patrilocal, exogamous, territorial bands.

Recent studies among some hunting and gathering bands have shown these bands to be open, bilateral, non-territorial and flexible in composition.²⁰ This seems to best describe Raute secondary band organization. I was told that when the main band divides the only criteria for secondary band membership was preference for

²⁰ Lee, Richard "The Kung Bushmen of Botswana", in M. Bicchieri (ed.), *Hunters and Gatherers Today*, New York, 1972, p. 350.

each other's company. In visiting secondary bands, I found that even brothers had divided into different groups. These secondary bands are said to constantly change in composition as the main band reforms and divides again later, and they were in no way exogamous, unilocal, unilineal or territorial in character. If Murdock's theory as to the conditions necessary for the development of clans is correct, then it is obvious that in Raute society the conditions do not exist.²¹

I was unable under the circumstances to be able to see any pattern to the way the Raute camps are organized. In figure 3, I have shown the plan of a camp made on the flat shoulder of a hill; in figure 4, that of one on a terraced field; and in figures 5 and 6, two sites built by the two secondary bands, figure 5 being that of one on a hill and figure 6 one on a terraced field. These camps were all populated for at least one week. There seems to be no set pattern, although it is interesting to note that in figures 4 and 6 there was much more space for building huts than was actually utilized, indicating perhaps that certain spatial concepts as to distance between huts may play a role in determining the limits of camp size. The Raute claimed that there was no particular order to the setting up of a camp or as to who would be living next to each other, beyond the general attempt to have widows live in the center for protection and the mentally disturbed men live on the outer edge of the camp. It is not necessary for close relatives to live together, although a few might do so.

In selecting a site the Raute said they try to choose one centrally located, near surrounding villages but out of sight of them if possible, and near a good supply of wood and water. The entire band might leave for a new site together, but more often they stagger their departures and leave in small groups.

There are normally 35-36 huts, including those which are divided or built adjacent to one another. I was told that these normally consist of extended families but may not necessarily be so. If one estimates 3-4 people per hut, one arrives at a figure of between 105-140 as the population of the tribe. This tallies well with a visual count of 103, which did not include babies nor some people who left camp prior to when the count was made. This also compares well with the number of 126 counted in a kinship survey. The chart shown in figure 7 does not include people for whom I had no data as to their kinship relation. The chart is based on very short interviews with 18 Raute men and boys (I was unable to interview any women), and much of the information could not be checked. There are some contradictions and the data is certainly inaccurate in spots, but the general picture that evolved would seem to represent at least what the Raute want an outsider to know, if not the reality of their society. For that reason I have included it here, although it is only meant as an

²¹ Murdock, George, *Social Structure*, New York, 1949. p. 75.

indicator of trends rather than as an exact depiction of Raute kinship relations. As an example, number 2 on the chart stated that he married the sister of number 3. Number 1 said that number 2 was his father's mother's brother and that number 3 was his father's brother's son, hence one arrive at number 3 having married his sister's son's daughter (a second marriage it might be noted, however). Perhaps this is what the leader meant when he said they don't keep track of generations. Had the circumstances been different, this could have been more closely checked, especially the range of meaning applied to kinship terminology, which might well have been used in a classificatory sense. However, a serious effort was made to avoid this confusion in the elicitation of kinship terms, as they were used with everyone in the tribe whether or not their relationship was clear. The personal names used in speaking with outsiders are the same as those found among villagers and it was uncommon for a man to use the same name on two successive occasions. Only a few men used names frequently enough that other members of the tribe would know of them.

The chart does show to some extent the interrelatedness of the Raute population, and one would expect that in such a small, endogamous society a person would, be related to some individuals in more than one way. A fairly complete chart would undoubtedly provide a fascinating look into Raute kinship relations, but unfortunately this was impossible to obtain. Nonetheless, other patterns that are clear from the chart point to areas that the Raute themselves stressed, e.g., two brothers marrying two sisters, as with numbers 1, 4 and 5. This was considered an ideal marriage situation. That cross-cousin marriage took place can be seen by looking at number 6, although informants varied as to whether or not cross-cousin marriage was allowed. Another point stressed in conversations, namely that the Raute have many widows and do not allow widow remarriage, was also brought out in the kinship data where, including the people not included on the chart, there were 17 widows as compared to 3 unremarried widowers and 5 widowers who remarried. Again utilizing all the data collected, one arrives at a figure of 66 males and 60 females. That the males outnumber the females isn't surprising, as one would expect a slight imbalance in favor of males because of higher female mortality rates. These might be due to maternal losses at childbirth and stresses connected with multiple pregnancies. The Raute men do not have any dangerous occupation that would help in balancing this ratio.

It has been shown that statistically, in a band the size of the Rautes", an imbalance in the sex ratio is bound to occur.²² One might assume that infants are born at a rate of one in 3 years. If there is a population of 120, there may be 25 couples and

²² See: Washburn and Lancaster, *op. cit.*, p. 302, for a discussion of the statistics I am using in this section.

8 babies a year of which perhaps 3 may reach adulthood. Thus the net production would be 3 children a year in a population of 120 and chances would be that small departures from a 50/50 sex ratio are quite common. It would take about 100 pairs to produce enough children so that the sex ratio would be close enough to 50/50, and this would require a population of about 500 people. With the Raute numbering so few, there would be constant fluctuation in the sex ratio large enough to cause social problems, a point to which I will return later.

This brings us to another related area, that of marriage patterns. When questioned, the Raute were inconsistent in formulating rules as to whom one should or shouldn't marry. They would simply say that one should marry into a "friend's" family. One would like to know the Raute kinship terminology as it might help clarify some points here, but with the exception of two terms, "kua" for mother's brother and "jia" for mother, I was told that all terms were the same as in Nepali. Based on my work with the related Raji tribe, I strongly doubt this, however. Some Raute said that a man should marry into the family his father had married into and stressed that multiple marriages were best, i.e., where either brothers married sisters or where one's sister would be exchanged for the sister of another. This latter type would, if a man did marry into the family his father had married into, result, in the next generation, in a man marrying his father's sister's daughter and mother's brother's daughter at the same time, as they would be one and the same. Although a few Raute I talked to denied cross-cousin marriage at first, they admitted that it could occur under these circumstances. That, of course, is part of the problem. In a society with the limited marriage possibilities of the Raute, one would not expect broad marriage rules to be at work and it seems doubtful that marriage prohibitions would extend beyond one's own parallel first cousins, if that. A hypothetical case as mentioned above would be an extreme rarity. Reasons for multiple marriages would be easier to understand in a hunting and gathering society consisting of small exogamous bands, as it would have the advantage of keeping siblings together, or at least in a simple sister exchange there would be a bond between the families involved which could serve a variety of purposes. But among the Raute with close physical proximity among all of its members and fluid secondary band composition, one wonders why its importance is stressed. Part of the answer may be in historical factors to be considered later.

The claim of the Raute that widow remarriage is not allowed presents several problems. One might think that this claim is simply another attempt to show their high caste origin, as this custom is also shared by the higher Hindu castes. Also, it would seem strange to have loose marriage rules but strong marriage prohibitions after the death of a spouse. Most hunting and gathering societies are quite loose about marriages, and members may be married several times in their lives. It is also not un-

common to find young men in such societies cohabiting with much older women before finally marrying. Yet in interviewing 18 different people, it would seem difficult for such a clear pattern to emerge without having some basis in fact. One wonders, however, how there can be so many unmarried, albeit widowed, women in a society with an excess of men, presumably some of them desiring wives. I personally think it unlikely that widows cannot cohabit with men. Whether or not this would constitute a "marriage" in the eyes of the Raute is another matter, and the problem may be simply a semantic one. But what if it is not? Are there more widows due to older men marrying, or remarrying, younger women and hence dying before their wives? Would this be a means of population control?

There is no polygamy in Raute society, but a man can remarry if his wife dies. There is said to be no levirate or sororate, but a man will take care of his brother's wife if his brother dies, his son's wife if his son dies, his wife's mother if there be no sons to care for her, his father's brother's wife, and so on. In the event of the band dividing, the widow would remain with whoever was caring for her.

A man builds his own hut once married, but until a man and his wife can become self-sufficient, they may live in a partitioned hut with his parents in order to use the cooking utensils. Widows live in their own huts even when cared for by another family. In the normal marital situation a monogamously married couple makes up a sexually, economically and residentially distinct family group.

I was told that there was no joking or avoidance behavior between classes of relatives. One would not expect strong joking or avoidance behavior patterns to exist in a society which is so small, with its members living in such close physical proximity, and in which strong marriage preferences for distinct classes of relatives are lacking. However, in discussions with the Raute it seemed that there were feelings of strong bonds between brothers or between unrelated men—in one case not included on the chart—who had married sisters. These were the men most often brought up in discussions of kinship, and one would like to know more about how this bond might function in practice in the society. In some hunting and gathering societies affinal relationships play a very important part, sometimes almost to the exclusion of consanguine ones. These and other points require further research. One would especially like to know how relations between tribal members work in reality, e.g., exchanges that take place, behavior patterns, cooperation among members, etc.

POLITICS

Earlier in this paper mention was made of a Raute leader, and it is to this and related topics that I will now turn. I was at first struck by the central position that one man held, as it seemed to go counter to what I had read about leadership in the

majority of egalitarian hunting and gathering societies. On closer examination, however, it became clear that there was a great difference between the external and internal sides of the political sphere.

Externally it was usually one man who dealt with villagers. It was he who had the greatest skill in manipulating them, and his cleverness was acknowledged by Raute and villagers alike. I would watch with interest as he would be entirely pleasant with some newcomer, feeling him out to see who he was and what he wanted, and then react accordingly, being as ill-tempered or pleasant as he felt the situation required. He showed little of the fear that other Raute showed when dealing with outsiders and, as he himself said, "Who could be a leader who is afraid to talk to villagers?" In most situations in which a group decision wasn't necessary, he would speak for the group. Other Raute would often refer outsiders to the leader, if the situation went beyond the usual. For example, a conflict arose in which a villager asked a Raute to make a box for him and gave the Raute a note to his wife in which he asked her to give the Raute grain for the box when it was ready. Apparently he later met another Raute on the trail and asked him to make one also. When the two Raute arrived that night with boxes, the villager's wife only took the one from the man who had the note. The second man complained to the leader. Later the leader met the villager, but he denied asking the second man to make a box and refused to take the extra one made when the leader said he should. The leader agreed to talk again with the second man and the matter ended, but not without this villager being spoken ill of by the Raute whenever the affair was brought up.

This points out the role that the leader plays in dealing with affairs outside the group and also points to another characteristic that the Raute share with some other hunting and gathering societies, namely that of viewing other groups as threatening and one's own group as the only possible source of emotional and social satisfaction.²³ At no time was there any feeling that the second man had lied, nor was there any enmity between the two Raute involved. This had been entirely directed at the villager. As has been pointed out previously, the Raute have little to do with villagers beyond the necessary trading of wood objects, and there is a degree of mutual fear existing between the groups. The view of the Raute that everyone outside their immediate group is a potential threat, seems to be based not only on conflicts between the groups that rose in the past but also on the need to direct hostility outside of their immediate group in order to keep it functioning smoothly. A circle is formed wherein the Raute live a nomadic life and are outside the normal realm of village

²³ For a description of this characteristic, referred to there as "emotional inbreeding", see Cohen, Yehudi, *Social Structure and Personality*, New York, 1961, pp. 19-23.

life, are feared to a degree, and can make no lasting contact with villagers, which in turn insures that they will be that much more closed into themselves and less apt to ever break this pattern of relations. Group solidarity is necessary for their own defense. Thus when the leader cannot cope with a situation himself and the group will be affected by the outcome of a decision, the matter will be discussed among the men and either group action will be taken or the leader will take steps on behalf of the group to settle the difficulty.

Here we begin to see the difference between the external and internal conflicts, for those that arise within the group itself are not handled by the leader, but rather through discussion where only men who are able conciliators will have any influence. Whether or not this includes the leader depends on his ability as a conciliator, and it is not at all certain that his opinion will be followed. The term "leader" is used here to refer to the man primarily responsible for dealing with outsiders, and no leader as such exists for intergroup affairs. I was told that decisions as to a camp site, hunt, etc., are made through discussions with no one man necessarily dominating. Any attempt on the part of the leader to force something on the people with which they aren't in agreement would simply result in their not paying any attention to him.

This conforms more to our idea of hunting and gathering societies usually being egalitarian and was pointed out in other ways also. In observing male-female relationships it appeared that the female had as much say in inter-familial affairs and showed no fear in voicing her opinions. The non-inheritance of goods may also be another means of preventing inequality. There is also considerable autonomy, as any individual can hunt, trade or whatever, as he pleases, so long as he doesn't do something that would cause harm to the group. Thus the picture that emerges is one of an egalitarian, personal and individualistic society which acts as a cohesive, closed group in dealings with outsiders.

As tensions within any society are unavoidable, one would expect that ways of resolving conflicts would have developed which are in accordance with the basic rules of the lives of its members.²⁴ There is no formal mechanism for this in Raute society, but there seem to be two personal and two social mechanisms at work. The personal mechanisms are the conscious withholding of hostility and the redirecting of aggressive feelings outside the group. The two social mechanisms are conciliation and fission, the latter being of the family in interfamilial conflicts and of the band in larger conflicts.

It was mentioned earlier that the imbalance in the sex ratio might be the underlying cause of some social problems, e.g., adultery, and one would expect that oc-

²⁴ This follows Gardner, *op. cit.*, pp. 431-432.



Plate VIII. Two men working on wood objects prior to the morning meal. The wife of one of the men is emerging from a smoke-filled hut.



Plate IX. Two boys working together on the construction of a wood box.

casual conflicts would arise that could only be resolved through temporary division of the main band. This was admitted by one informant, but he stressed the rarity of its occurrence. Indeed, the leader stressed the lack of any internal conflict at all and said that because they have no animals or land there is no reason to quarrel. This seems to simplify the actual situation, and I observed on a few occasions when beer was drunk that serious arguments did break out. These appeared to dissolve quickly, however. One would also suspect that conflicts might arise on occasion due to incidents arising in the distribution of food. But serious conflicts are undoubtedly rare in a society organised like that of the Raute.

LIFE CYCLE

While questioning Raute about life cycle events, I was invariably told of customs that paralleled those of the high caste villagers. Eventually I was able to arrive at some better idea of the true situation, but the data I have collected are relatively scanty. This is no doubt due in part to these events not being quite as elaborately treated as among the more affluent villagers.

I was told that there are no prohibitions connected with economic activities during a woman's pregnancy and that there is no pollution connected with childbirth. Birth takes place in the forest, and only women are allowed to assist. The women return after the baby has been delivered and in a few days life goes on as normal. Kinship terms are employed among the Raute and no names are given except those made in fun. These are often used for only a short period of time. Thus, contrary to the villagers, there is no special name-giving ceremony nor is there a first rice-feeding ceremony for the baby.

Babies are indulged and allowed to breastfeed as often as they desire and are kept most of the day and night by their mothers' sides. Some men told me that after a baby is born the husband and wife will no longer sleep together for several months, the woman with baby sleeping on one side of the fire and the man on the other. One would expect that with a nomadic hunting and gathering subsistence a mother would have a difficult time breastfeeding and carrying two children, and these may be reasons why men agreed that it was normal to have one child every 3-4 years.

Children appeared to have a carefree life, running and playing at will throughout the camp. They play with carved wooden models of such items as boats and use sticks for pole vaulting over obstacles. They also wear clothes similar to those of adults and help adults with various tasks as best they can. A few people always remain in camp to look after it and the children. The relative lack of responsibility among Raute children might be compared to the case of village children, who have a large responsibility caring for large animals in an area without fences. One anthropologist has pointed

out that differences in child rearing practices might partly explain the independence shown by hunters and gatherers and their reluctance to change their ways.²⁵

No special activities are connected with puberty, although a girl's first menstruation is said to show she is ready for marriage. Girls marry at about 15-16 and boys between 20 and 25 years of age. I was told that no sexual relations take place prior to marriage. If a boy wants to marry a girl he must receive his parents' permission and, should it not be forthcoming, no marriage can take place. The Raute said that they never quarrel with their parents. There is no special time of year for marriages to take place. They occur soon after the boy's father has made the arrangements. A feast is given for the bride's and groom's primary relatives and in the evening the boy gives the girl a necklace, and then tikkas (auspicious marks put on fore-heads) are exchanged between them. They are then considered wed. The same evening the boy and his father go to the girl's parents and give them specially prepared breads signifying that a new relationship exists between their families.

The newly married couple remain with the boy's parents or build their own hut immediately following the wedding. They eat with the boy's family until there are sufficient utensils for them to eat separately. The cooking pots and utensils are divided as soon as it is feasible. The son and daughter receive equal shares because they used them previously and are considered to have an equal right to them.

There is little outward showing of affection between a husband and wife, but it is indirectly shown through such acts as a woman cutting her husband's hair and physical proximity of the couple while resting or working in camp. Divorces are said to be rare and, indeed, it was claimed that a woman may not remarry if she leaves her husband. This custom, along with some other customs mentioned above, may only represent the pattern of behavior which the Raute want an outsider to know. One would expect more flexibility than was claimed to occur in such an egalitarian and individualistic society as this one.

There is little that one might call recreation or entertainment in Raute society on a day to day basis. Dances are rare and depend on a surplus so that beer can be made or upon villagers arranging for them to be held. Women will only dance and sing when not observed by villagers. They dance separately from the men but do the same type of dance. The dances are circle dances with variations in steps and changes in directions taking place often in the course of the performance. The Raute have two drums made by a village caste, and several men possess special clothing which they wear only while dancing. Some men also wear hollow metal rings with metal balls

²⁵ Murdock, George "Discussion : Are the Hunter—gatherers a Cultural Type ?" in R. Lee and I. DeVore (eds.), *Man the Hunter*, Chicago, 1968, p. 337.

inside on their ankles. These are obtained in trade from village blacksmiths. There is no formal instruction in dancing or drumming and anyone may participate who has the ability. In the dances I observed there were two drummers and one song leader. The number of dancers varied from 15 to 34. For these dances I gave the Raute three goats. One dance involved the use of wood sticks, and all the dances were familiar to villagers present. Indeed the two songs sung were both in Nepali and of no symbolical significance to the Raute. It was obvious that everything relating to song and dance had been borrowed from villagers.

Old people and those insane or ill are cared for by their relatives. If a person cannot walk, he is carried from camp to camp. The aged tend to take on easier tasks, such as watching the children and camp, and refrain from strenuous work. Old people are generally treated with respect, but this does not necessarily entail any increased influence in the group decision-making process.

All men of the tribe are present at the funeral of a person. The dead man is buried on the same day or, if he died during the night, the next morning. A rectangular hole about three feet deep and wide and six feet long is dug. The dead man is carried in his hunting net and buried fully clothed in the net along with all of his personal possessions. Since they belonged to him, they are considered a part of him, and no one would use the tools of a person who had died. After placing the person inside, the hole is filled with dirt and covered with stones. It can be dug anywhere in the forest. There is no difference between burial for a man and for a woman. No worship of any deity takes place. Contrary to the custom in some parts of Nepal, there is no difference in the procedures if the person died an accidental or violent death. The camp is abandoned the same day of the burial and the site is not visited again.

There are few special observances after death. Only near relatives will mourn and a man's wife should not wear a glass bead necklace for a year afterwards. There are no eating prohibitions following death, and the Raute claim to have no fear of the dead nor any idea of what happens to a man or his spirit after he dies. However, if burial customs are any indication, then it would appear that the dead might be perceived as needing their belongings in the spirit world. The rapid departure from a camp site and disinclination to speak of the dead indicate some fear of those who have passed away. The Raute denied the rather peculiar stories told by villagers that they only wash their clothes when a person dies and that a widow may no longer eat the tail of a langur monkey.

RELIGION

The Raute are similar to many other hunting and gathering tribes in their dealings with the supernatural in that they lack elaborate rituals, priests and witchcraft.

The Raute claimed that their worship centers primarily around two deities, Bhuyar and Dare Mastah. Bhuyar is their hunting god and the deity they fear the most. They worship him especially at the full moon of the months of Asar (June-July) and Saun (July-August). The male head of each family should sacrifice a chicken or goat at a cleared place near his hut. Women are not allowed to participate. No purification of the place need be done, nor are special preparations, such as fasting, washing, etc., made for the worship. A stone representing the deity is set in the cleared area and a rice offering is placed on top of it. A prayer is said asking for success in hunting and then the animal is sacrificed by cutting its head off with a knife or an axe. Its blood is sprinkled around and on to the stone. Following the act of worship, all the band members share the meat equally.

Bhuyar is the god who becomes angry should contact with villagers become too intense and should villagers see monkey meat or the Raute while they hunt. This was one of the reasons given by the Raute for their desire not to live in view of villagers nor allow them into their camp. They claimed that there were no special observances, prayers, magic, etc., connected with any single hunt in particular, and only general worship of Bhuyar as noted above was performed.

The god Dare Mastah is conceived as being more beneficent and is worshipped at the same time as Bhuyar or may be worshipped at times of illness. A bell and a metal, human-shaped figure are kept in a wooden box and taken out at times when Mashta is worshipped. This box is carried by one man who is responsible for the care of the objects and the use of them at worship. The worship occurs at any open area and people make offerings of rice, but no sacrifice is done.

Aside from these two deities two other forest gods, Ban Devi and Ban Jhankri, are worshipped should they cause an illness. There is also a general fear of unnamed evil spirits which cause harm on occasion. Ancestors are not worshipped, and the Raute professed ignorance of a soul or knowledge of an afterlife. The sun is associated with the more general term for god, Bhagwan, but no worship of it or particular beliefs about other natural phenomena such as the moon, stars, etc., were said to be held. The Raute claimed to exchange tikkas and celebrate with dancing and drinking on Daisain, a major Hindu festival, but they did not know the story behind this festival nor carry out many of the observances which most village castes do at this time.

In first questioning the Raute about what deities they worship, they would invariably say they worship all the same deities that villagers do, naming such well known gods as Vishnu, Shiva, etc. Indeed all the deities mentioned above are common in this area and one would like to know if Raute claims concerning their beliefs and

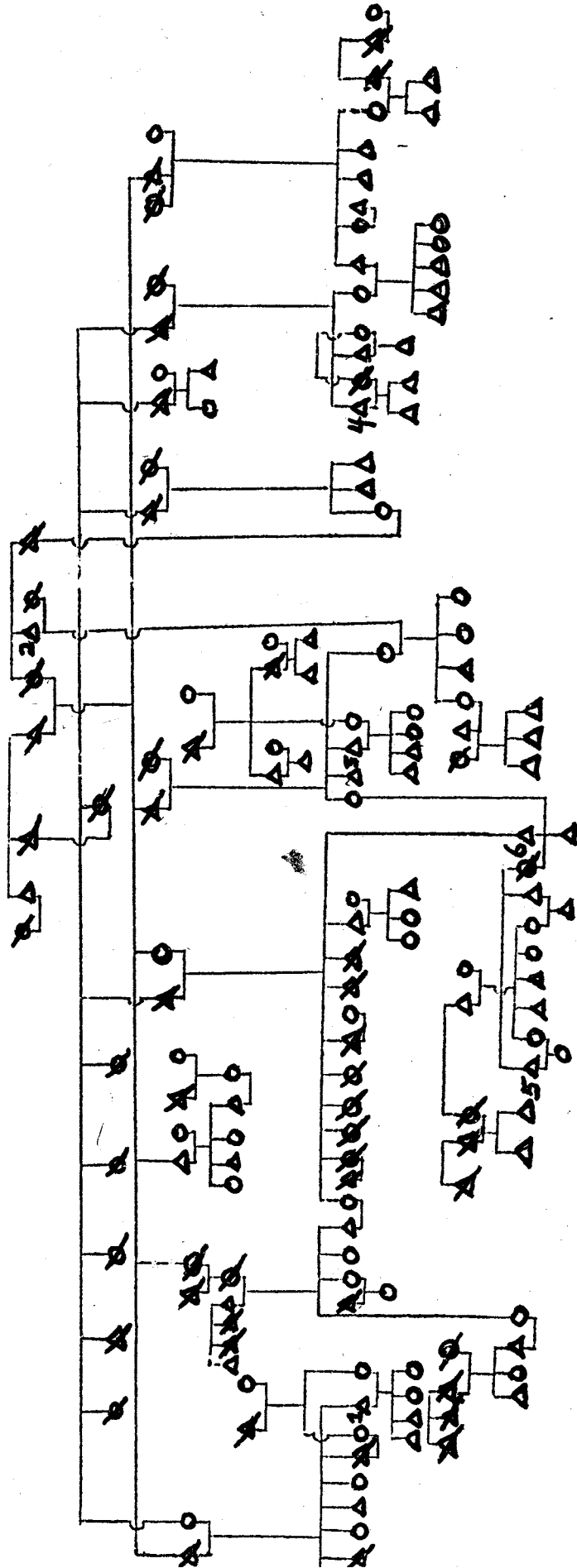

△ male
○ female
△/ deceased (male)
— marriage
⊥ siblings

Fig. 7.

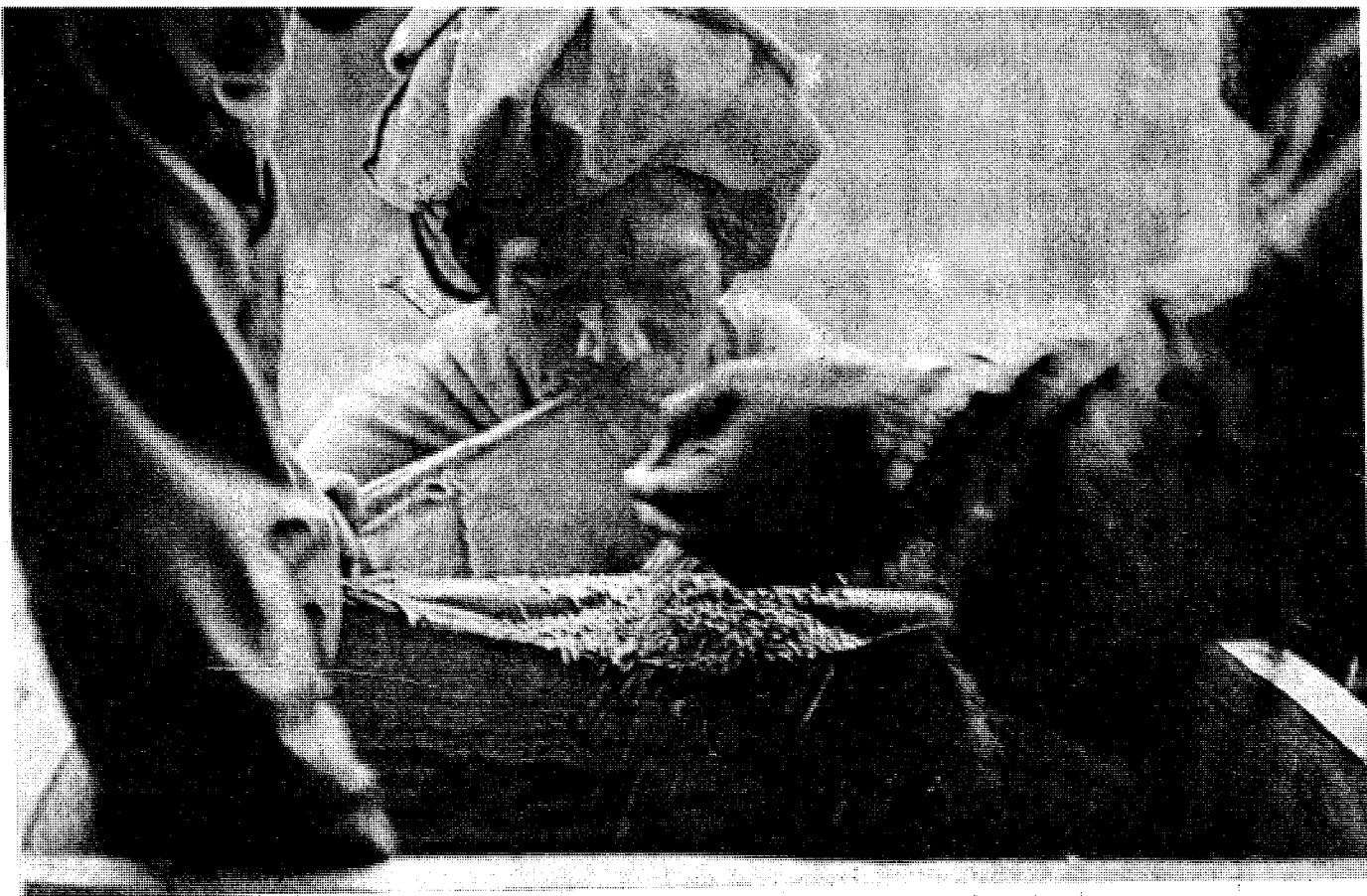

Plate X. The Raute leader is holding a sack open while men pour in grain he obtained in exchange for the wood box it filled.



Plate XI. A woman prepares a meal while others relax near a rice husking area.

practices are in fact true.²⁶ They have obviously borrowed Hindu beliefs and customs to some extent, e.g., they wear the Hindu topknot, but seem not to have learned the underlying rationale for them. Furthermore, initially they claimed to worship at Sano Dasain and not to cut trees on a full moon day (a practice similar to the villagers' of not plowing on this day), but I was present at these times and did not witness any change in the normal routine. The Raute admitted later that what they had told me was untrue. Because even the little data presented above may well prove to be false, I have not gone into any interpretation of it nor drawn any comparisons with practices to find out more about their hunting beliefs and about the box containing objects of worship. The Birhor, a hunting and gathering tribe in India, are also reported to carry a "spirit" box with them which contains animal skins, horns, etc., and is used at times of worship of mountain spirits.²⁷ Yogi Naraharinath mentioned that the Raute keep a manuscript in a special wooden box which is written in the Raute language in Devanagari script and contains information on genealogies and the history of their tribe.²⁸ They denied this, and it does seem unlikely to be true, but in any event one would like to know more about what is kept in the box and its importance in Raute religion.

Although the Raute have a reputation among villagers for being excellent sorcerers, no evidence of this could be found in my work with them. On the contrary, they often complained that they only have one old shaman who knows very little and is not able to cure their illnesses. They often asked if I knew any spells or had any medicine for headaches, fevers, backaches, colds and the like. They use butter on burns and the sap of trees on cuts, but disclaimed having extensive knowledge of medicinal herbs. Chronic illnesses, specially those associated with old age, are said to be infrequent among hunting and gathering societies, and, contrary to village practice, the Raute have no food prohibitions at the time of an illness so that nutritionally one would expect them not to suffer. That their health and diet appears better than that of villagers has been mentioned earlier, and one would expect that the drinking of only spring water would eliminate to some extent the gastro-intestinal diseases that plague the villagers. The primary hazards to the Raute would appear to be connected with the cutting of wood and killing of monkeys. In general one would imagine the Raute to be in better health than villagers.

26 All of these deities have appeared in accounts previously, e.g., in Crooke, W., *The Popular Religion and Folklore of Northern India*, 2 vols., New Delhi, 3rd reprint 1968, but a particularly fine account of the god Mashta appeared in Gaborieau, Marc, "Note préliminaire sur le dieu Mašta", in *Objets et Mondes*, Vol. IX, Part I, Paris, 1969, pp. 19-50.

27 Roy, S.C., *The Birhors*, Ranchi, 1925, pp. 121-122.

28 Naraharinath, *op. cit.*

The shaman does not have the special clothes or instruments used by some of the village shamans in this area.²⁹ He is unable to mechanically divine causes of illness, and only at times of severe illness will he call a deity which will possess him and speak through him to explain the cause of the illness and what should be done to cure it. Normally this involves a sacrifice or food offering to the deity or spirit responsible. There is only one shaman, and should he die then another man will eventually become possessed and be the new one. The shaman is the only person who can become possessed. The Raute claimed that there was no witchcraft.

The Raute have a custom of not selling or trading objects they have used themselves and of deliberately destroying objects that must be left behind when leaving a camp site. This may be due to the belief mentioned earlier that an object consistently used by a Raute is considered almost as a part of him. The Raute will sometimes burn huts or occasionally an entire camp upon leaving, but they denied that this had any meaning and said it was done only in play or in order to please a farmer upon whose land they had settled. Villagers claim that the burning of huts and breaking of objects is due to the Raute belief that others may use them and stay where the Raute had been, thereby ruining their hunting in the future.

Contrary to what one might expect, there was said to be no worship connected with food gathering, such as a first-fruit ceremony, nor with wood working. The major emphasis seems to fall upon hunting. Often the Raute stated that it was god who made them hunters and gave them monkeys, and so it was meant to be always. Beliefs connected with hunting would appear to reinforce the we/they dichotomy that exists between the Raute and villagers, and set limits on the degree of interaction that can take place between them. Although other factors are certainly at work, one can see that religion plays an important role in the economic-social relationships existing between these two groups.

RELATIONS WITH VILLAGERS

The relationships between the villagers and the Raute have been tainted by misunderstandings and erroneous beliefs held on both sides. Stories that are commonly told about the Raute are included here as an indication of the way that at least some villagers view them.

When I first went to search for the Raute it was difficult to find porters willing to accompany me. I was often told that if I didn't do exactly what the Raute told me

²⁹ For a description of clothing and instruments commonly found among shamans in this area, see Hitchcock, John, "Nepalese Shamanism and the Classical Inner Asian Tradition", in *History of Religions*, Vol. 7, No. 2, 1976, pp. 149-158.

to do, they would kill me, and they were reputed to kill anyone who entered their camp or who stepped over a line drawn in front of their huts. They were spoken of everywhere I went as being able to steal women and children with their magic. One story was of a woman who told the Raute to go away because they smelled. That night she disappeared from the village, never to be seen again.

Another story was of an Indian Army man who, while returning to his village with his wife, encountered a Raute campsite. The woman asked the Raute for a burning log so that she could start a fire. After she was given it, the Raute man who gave it to her claimed her as his wife, because she had taken coals from his fire. In the argument that followed the Army man killed 3 Raute and fled, but he was later killed by Raute magic.

Raute are said to steal children for use in sacrifices. A hole is said to be dug and the child is placed in feet first with dirt tramped into the hole until only his head is showing. Then an iron spike is pounded into the top of his head and blood is squirted up for the Raute deity. Village parents are known to tell their children that, if they don't let them pierce their ears, the Raute will take them, the point being that the Raute would not be able to use a deformed child for their sacrifice.

Another belief quite common among villagers is that the Kusunda, a hunting and gathering tribe now almost extinct, collect taxes from the Raute. Because of a fear of taxes, the Raute are reputed to run off at the sight of a Kusunda.

Villagers also claim that Raute marry their own sisters. The reputation of the Raute is sometimes discussed in milder terms. Their bluntness, dislike of listening to others' advice, dislike of repeating themselves, and quick tempers were topics often stressed in my talks with villagers. I found that these comments were not entirely unfounded.

The Raute are not unaware of the stories told about them and an easy way to find out that their reputation for quick tempers is not just hearsay is to bring these stories up in a conversation. The leader reacted by saying, "We are men too and how could any human being do the things attributed to us? You should cut my hand off or put your foot on my head if you don't believe me".

However, the Raute don't help matters any by some of their actions and the sayings for which they are justifiably well known. In conversations with villagers clever sayings are often given as answers to questions, and these sayings give insights into some Raute attitudes. "Give me a sack of rice and a waterpipe any day before friendship with a villager", was typical of those I heard, and I expect they meant it. Some Raute were given to putting a bold face to their relations with villagers and their lack of fear of anything. "We don't fear malaria, we don't fear the

government, we don't fear tigers, we don't fear anything", was a saying heard in various forms several times. But that the Raute do fear the villagers and the clearly dominating position they hold was made clear in many ways. One of these was the obvious concern and anger shown at any mention of their being settled and forced to take up agriculture. The Raute are quick to say that they would rather die first and that they wouldn't hesitate to fight to keep their way of life. They know that there has been talk by government officials of their being forcibly settled, and they appear to be quite concerned about this. Their mistrust of villagers might also be shown by an event I witnessed where candy was offered to the Raute by a villager. They asked if it was poison and refused to take it until a piece had first been eaten by the villager. They are known for avoiding situations that might lead to prolonged contact with villagers even when it would be beneficial to them. An example to this in relation to myself occurred when the leader asked me for a piece of plastic to use as a rain cover, but, when I said I would give it to him a week after, he refused to consider it. A similar situation occurred when arranging a dance. It had to be done immediately or not at all.

In their usual dealings with villagers, and especially in contacts with government officials, the Raute are quite pleasant. This seems to be due more to the necessity of maintaining good relations for trading purposes and winning sympathy for their situation so there will be no interference later than to any desire to develop sincere friendships with outsiders. Much the same may be said for the practice of becoming a "mit", i.e., a fictive brother, of a villager. This may be done without a ceremony of any kind, but usually involves at least the exchange of presents and wishes of good will to one another. Among villagers this relationship can have important behavioral concomitants just as would exist between real brothers. As might be expected, this is not quite the case with the Raute, however. The leader claimed to be a "mit" with an Indian shopkeeper in Surkhet, although later in checking I could find no such person. He became "mit" with me probably more from a desire for the gift obtained in the exchange and the ability to claim the relationship among villagers later for status reasons than from any wish for a long-term friendship. Beyond referring to me as his "mit", there was no significant change in the way he acted towards me.

One would expect with the kind of in-group solidarity characterizing a tribe like the Raute that its inevitable concomitant would be intertribal antagonism. Certainly the situation that exists between the Raute and villagers is not one of constant, open hostility, but the sources for conflict are there, and conflicts have occurred in the past.

When the mechanisms of avoiding conflict with a dominant group through avoidance of unnecessary contact and repression of feelings of dislike and hostility

no longer can function and the resolving of the conflict cannot be managed through discussion and conciliation, the Raute use a method employed by most hunting and gathering societies, namely, they simply leave the area. This is understandable, for even in the unlikely event that they might win in a serious conflict with the villagers, in their own system of beliefs they would lose simply through the staying and the increased contact with villagers it would involve. In this connection one might also see that one result of erratic patterns of movement would be that no one could know with certainty where the Raute would be at a particular time.

Normally, however, serious conflicts do not arise, and, although villagers certainly do not look with approval at what they consider the rather disgusting behavior of the Raute, they do not make an issue of it, either. This may to a degree be based on a fear of physical retaliation and sorcery, but seems more to be based on a live-and-let-live attitude and not a little fascination with this unusual tribe. However, there are ways that villagers will show their contempt without provoking an open conflict, e.g., by being surly with Raute and asking insulting questions and ridiculing them, or more subtly by such acts as not offering them a mat on which to sit, a courtesy they would extend to any villager. Although this is not uncommon, neither is it the norm, and the villagers appear to feel that as long as the Raute don't bother them, they won't bother the Raute. Also, as has been stated previously, there is a fair demand for the wood objects the Raute make.

The we/they dichotomy so exemplified by the beliefs and practices mentioned above should not allow us to overlook the great influence that village culture has had on Raute society. Most of the material culture of the Raute has its source in the village, and not a few of their beliefs and customs, be they in religion, music or whatever, appear to have their origin in the village. Some features of village culture that the Raute have adopted, such as Nepali language, tools, etc., are undoubtedly due to necessity, with many other proclaimed beliefs and customs being more examples of token assimilation than having any true place in Raute society. The Raute personal names are Nepali names and only used in contacts with outsiders. The claims made when one first meets the Raute as to their position in the caste hierarchy, their social structure, religion, and life cycle events seem to be more an attempt to avoid ridicule, being attributed a low status, and laying any possible base for interference in their affairs than to anything else. However, the Raute could not live physically independent of the villagers in this populated area even if it were economically feasible to do so. Inevitably some acculturation would take place through time. The Raute seem to recognize the economic, religious and, above all, political superiority of the villagers. To what extent this might present an underlying feeling that the villagers have a better way of life remains to be seen. The interplay between the we/they dichotomy on the

one hand and the genuine acculturation taking place on the other is one which will continue to mark Raute relations with villagers in a distinctive way for some time to come. If the Raute have their way, this will be a long time indeed.

CULTURE CHANGE

Without historical documents or oral tradition it is impossible to state with any degree of certainty what took place to bring about the Raute culture as it is today. However, based on what is known of the Raute and other tribes and developments in the area, one may make some interesting, and probably not too far-fetched, speculations about changes that have taken place in the not too distant past. The question that first comes to mind is how is it that the Raute are still hunters and gatherers in an area where other hunting and gathering tribes have long since become settled agriculturalists ?

In looking closer at these hunting and gathering tribes two things seem to stand out differentiating them from the Raute. All those which have settled, be they Raji, Kusunda or Chepang, were hunters with bows and arrows and developed no firm subsistence base through trade, or whatever, which would enable them to remain nomadic. The increased population in the area with its concomitants of increased deforestation, overgrazing, burning of the forest to bring about fresh foliage, hunting and gathering by villagers, etc., would obviously mean that there would be less resources for a hunting and gathering tribe and less available land in which to exploit them. Bow and arrow hunting probably became more individualistic, if it was not so previously, entailing gradually longer forays to collect sufficient food, and in any event could not provide a quick supply of a large quantity of food in order to have a secure subsistence base. One would suspect that large bands of more than a hundred people were rare, and, in order that a bow and arrow hunter would not have to travel long distances, smaller bands of perhaps fifty people were the norm. This coupled with a lesser availability of forest produce— which probably provided the main subsistence base— would eventually cause the break-up of large bands and lead to taking up agriculture in order to survive. Marriages probably took place between bands and multiple marriages, by keeping siblings together or, in an exchange situation, enabling alliances between bands to develop, may well have been common. This somewhat simplifies a complex process that I have been able to document with the Raji and Kusunda, but it provides one with a general idea of the situation which confronted the Raute.

If stories about the Raute and comparisons with the Raji are any indication the Raute may well have hunted other animals in the past. However, it is in the hunting of monkeys with nets that a large quantity of food can be obtained in a short period of time. In addition they are a fairly constant source of food as villagers do not kill them nor would conflicts arise, as villagers are all too happy to get rid of monkeys which ravage their crops. This anchors one end of the economy down, but what about the reliance on gathering forest produce as a subsistence base? As this decreased and more areas were settled, it seems that the Raute began to resort to the trading of wooden bowls for a part of their subsistence. Again using the Raji of SW Nepal and Kumaon as examples to draw from, this may well have first occurred through the so-called "silent trade" where bowls would be left at a place one night, and the next night food left by villagers would be taken.³⁰ With more areas settled it would become increasingly difficult to avoid villagers, and the need for a more secure subsistence would rise. As the area is far from markets where wooden objects or their substitutes could be obtained, the Raute must have slowly begun to trade more and eventually made a wider variety of objects according to demand. More contact with villagers meant increased need for tools and some borrowing of villagers' beliefs, customs and language. It also meant a greater need for leaders to deal with the more sophisticated villagers. With the need for cooperation in hunting and a relatively secure subsistence base, the possibility exists that the fairly large band size which the Raute have at present may be a more recent development. They stressed on more than one occasion that band division was dependent upon trading, not upon hunting, as there would still be sufficient numbers of men in a secondary band for a successful hunt. In the past the closely related Raji were also nomadic hunters and one might expect intermarriage between bands to have taken place setting a premium on multiple and exchange marriages.

On much less firmer ground, one would think that at least some of the stories of women being "stolen" by the Raute are based on fact. There may well have been village women who simply decided to run off and live with the Raute. The strong rule against contact with outsiders may have been bent or not as firm as it is today, as the number of marriageable women declined with settlement of the Raji. At least this would help to explain the mixed physical traits the Raute exhibit. Although kidnapping of children in this area was not at all that uncommon 150 years ago, nor was human sacrifice entirely unknown in India in those times, there is nothing that would lead us to make any judgement as to the validity of villager beliefs about the Raute

31 Regmi, Mahesh C. 'A Study in Nepali Economic History' p: 167 of the unpublished manuscript. This book has since been published in New Delhi, 1971.

in this regard.³¹ However, there must have been occasional acts of hostility encountered by the Raute from villagers who hardly viewed them as human beings, and this may well have set the foundation for some of the beliefs of the Raute and the situation that one finds today.

Looking into the future, it would seem that the Raute will be able to continue their present way of life for some time to come. As a fair amount of forested land will remain unsuited for cultivation, there should be no lack of forest in which monkeys can live and from which Raute can obtain wood for wood-working. Monkeys are still common and will probably remain so, and there appears to be a steady market for wood objects made by the Raute. This last factor is the one that might begin to cause them difficulty as roads are opened up and other objects come into vogue, although perhaps the increase in population and poverty of the people will keep Raute wood objects in demand. The primary concern of the Raute, that of being forcibly settled and/or action taken against their cutting of trees, seems now to be removed, as the King is said to have issued orders to prevent harassment of the Raute.³² This enlightened action taken on the part of the King will help prevent some of the problems that have arisen in similar situations elsewhere, e.g. among the Birhor in India, where forced settlement had more disadvantages than benefits for the people.³³ But change will undoubtedly come, and one hopes that it will be of the kind that arises gradually and along with the changing needs and desires of the Raute.

This paper has been based on very little data, some of which is no doubt inaccurate, and on speculation, interesting and suggestive, but speculation nonetheless. Perhaps the only thing that justifies its publication is the fact that no comparable work has appeared on this tribe, and it is doubtful that a more detailed study can be carried out with the Raute under the present circumstances.³⁴ I had found the kind of tribe with which I wanted to live, a nomadic hunting and gathering tribe unique in this part of the world today. But now I realize I may have desired the impossible. For such a tribe to exist which would accept an outsider may be a contradiction in terms. Only

30 Tiwari, S.C. "The Rajis (Royal Wildmen of the Forests) of Askote, District Almora, U.P.", in *Vanyajati*, Vol. I, No. 3, 1953, pp. 52-53.

32 Personal communication with Dr. Carleton Coon.

33 Sinha, *op. cit.*, pp. 398-400.

34 I intend to return to Nepal for a more intensive study of culture change among the Raji-Raute, but will gather data concerning the Raute which will not necessitate prolonged, direct contact with them.

by avoiding outsiders with the strongest resolution founded on an unshakeable religious belief have they managed to remain as they are today. I only hope that they may continue to keep the way of life which they so fervently and proudly subscribe to as their own.

* * *